

# Maestro M2e™

High Performance Pre-Amplifier  
Surround Processor  
with Active Balanced Technology

## Owners Enjoyment Manual

*For those who consider  
perfection possible®*

**AudioControl®**

22410 70th Avenue West • Mountlake Terrace, WA 98043 USA  
Phone 425-775-8461 • Fax 425-778-3166  
[www.audiocontrol.com](http://www.audiocontrol.com)



# Maestro M2e™

High Performance Pre-Amplifier  
Surround Processor  
with Active Balanced Technology

## Owners Enjoyment Manual

*For those who consider  
perfection possible®*

**AudioControl®**

22410 70th Avenue West • Mountlake Terrace, WA 98043 USA  
Phone 425-775-8461 • Fax 425-778-3166  
[www.audiocontrol.com](http://www.audiocontrol.com)

©2006. All Rights Reserved

Rev 1.1



This page was intentionally left blank. Please enjoy it!

**Maestro M2e™ AudioControl®**

Phone 425-775-8461 • Fax 425-778-3166

**Introduction** .....7

**Key Features and Highlights** .....8

**Guided Tour of the Maestro M2e**

    Front Panel Features .....10

    Rear Panel Features .....12

**Set-Up & Configuration**

    Unit Placement .....15

    Speaker Considerations and Placement .....15

    Power Wiring .....17

    Audio Connections .....17

    System Diagram .....18

    Video Connections .....19

    IR Controls .....20

    12V Trigger Connections .....21

    Zone 2 .....21

**Main User Menus**

    Navigating the Setup Menu .....23

    Inputs and Volume .....23

    Audio Settings .....23

    Zone 2 Settings .....24

**Advanced Setup Menus**

    General Settings .....25

    Speaker Sizes .....26

    Subwoofer Settings .....27

    Delay Settings .....28

    Level Settings .....28

    EX Settings .....29

    Speaker Eq Settings .....30

    Video Settings .....30

    Digital Settings .....30

    Zone 2 Settings .....31

    Input Trim .....31

    HDMI Settings .....32

# Table of Contents

---

<b>Operating The Maestro M2e</b>	
Power . . . . .	33
Menu . . . . .	34
Source Selection . . . . .	34
Stereo Direct . . . . .	35
Display Brightness . . . . .	36
<b>Surround Modes</b>	
Selecting Surround Modes . . . . .	39
<b>Automation Integration</b>	
RS-232 Serial Control Protocol Commands . . . . .	41
Protocol Structure . . . . .	42
Command Structure and Parameters . . . . .	45
IR Remote Control Codes . . . . .	49
<b>Troubleshooting</b>	
General . . . . .	51
Video . . . . .	51
Audio . . . . .	52
<b>Appendix</b> . . . . .	55
<b>Warranty</b> . . . . .	58
<b>Specifications</b> . . . . .	61

## Congratulations

Great attention to system design, installation, and calibration makes the difference between an average multiplex theatre and a great movie palace. For your own personal home theater experience, the choice of components and attention to detail is just as critical as if you were designing a professional installation. For that reason AudioControl created the Perfection Theater components to allow enthusiasts to experience a performance theater in their own home.

AudioControl's passion for high quality, meticulous attention to detail and pro sound heritage shows itself in the dozens of awards we have won for our designs, products and service. This manual is designed to help you get the most from your Maestro M2e pre-amp processor. Even though you're dying to plug it in and start pushing buttons, please take a little time to glance over this users guide and learn about the Maestro M2e theater surround processor. Any component that does as much as the Maestro M2e does, deserves all the explanation it can get.

## Most Important Instruction of All

Make certain the warranty card is filled out and mailed back to us. Also, record the serial number and put your sales receipt or invoice in a safe place. This is very important in the unlikely event that the Maestro M2e gets a sudden illness, or for proof of ownership if somebody takes a fancy to your theater system in the middle of the night. Insurance companies have no imagination when it comes to components like the Maestro M2e being part of the theater system. This concludes the nagging section of this manual.



**AudioControl** **Maestro M2e**™

Phone 425-775-8461 • Fax 425-778-3166

### Key Features Of the Maestro M2e

#### Multiple Surround Sound Formats

A powerful 32 bit DSP processor enables the Maestro M2e to decode all current discrete surround digital formats available for 5.1, 6.1 and 7.1. In addition your Maestro M2e has the capabilities to process two channel signals using Dolby Pro Logic II, Pro Logic IIx and DTS Neo to provide multi-channel output. The flash memory of your Maestro M2e will allow it to be upgraded in the future when new formats become available.

#### Balanced Outputs

The Maestro M2e offers balanced XLR outputs for superior signal to noise performance when interfacing with amplifiers with balanced inputs, like the AudioControl Pantages, Avalon, or Savoy.

#### High Definition Video Inputs and Switching

Great sound is important, but you also need a great picture to complete your performance home theater. The video routing and switching in the Maestro M2e has its roots in the broadcast studio. With high video bandwidth, you will see even the finest details from the video sources even with demanding 1080 and current progressive scan HDTV signals. In addition, the Maestro M2e switches high end digital video formats like HDMI for easy interface with today's digital projection devices.

#### AM/FM Tuner With RDS Support

The radio tuner in your Maestro M2e can receive both AM and FM signals. In addition, the RDS (Radio Data System) feature allows selected FM stations to display their respective names, song titles and even artists on the display of the Maestro M2e.

#### Extensive Automation Integration

A touch screen or automation system is what really pulls a high-end home theater together. It puts the full power of the system at your fingertips. The RS-232 serial port and infrared remote control inputs feature an extensive command library to control all aspects of the Maestro M2e. You have the power.

**Maestro M2e™ AudioControl®**

Phone 425-775-8461 • Fax 425-778-3166



### Active Balanced Outputs



BVR-25  
Balanced Video Receiver

The Maestro M2e is the world's first theater processor equipped with an Active Balanced Output which allows it to output a component video signal via an RJ-45 connector onto standard Category-5 wiring and extend it up to 1000'. The signal is also "balanced" which is a method used in professional video and audio to reject noise, hum, and distortion that can sometimes get introduced into signal paths. An optional (sold separately) AudioControl BVR-25 is used to receive this balanced signal and convert it back to a standard component video signal. This is then connected to your projector, monitor or other video display device. Because the Maestro M2e was designed with high performance video in mind, the Active Balanced Output on the Maestro M2e can accommodate high-resolution signals of 480, 720, and 1080!

### Second Zone Outputs

Do you want to enjoy your home theater system in the bedroom also? The Second Zone output of the Maestro enables you to independently control the source selection and volume to a room outside of the home theater.

### AudioControl Perfection Theater System

The Maestro M2e is part of the AudioControl Perfection Theater System. Also included in this system are the Diva Digital Room Correction Processor combined with the Avalon, Pantages, or Savoy high definition amplifiers. To maximize the performance of your Perfection Theater system, we also highly recommend that you have your audio system calibrated by a factory trained technician using AudioControl analysis equipment. Together these components ensure superior audio and video performance from your Perfection Home Theater system.

### Award-Winning Quality

The Maestro M2e, like all AudioControl Perfection Theater components, is backed with a comprehensive five-year parts and labor warranty. This comes from a company that has been designing and manufacturing performance audio components since 1977.



**AudioControl** **Maestro M2e**™

Phone 425-775-8461 • Fax 425-778-3166

## Guided Tour of the MaestroM2e

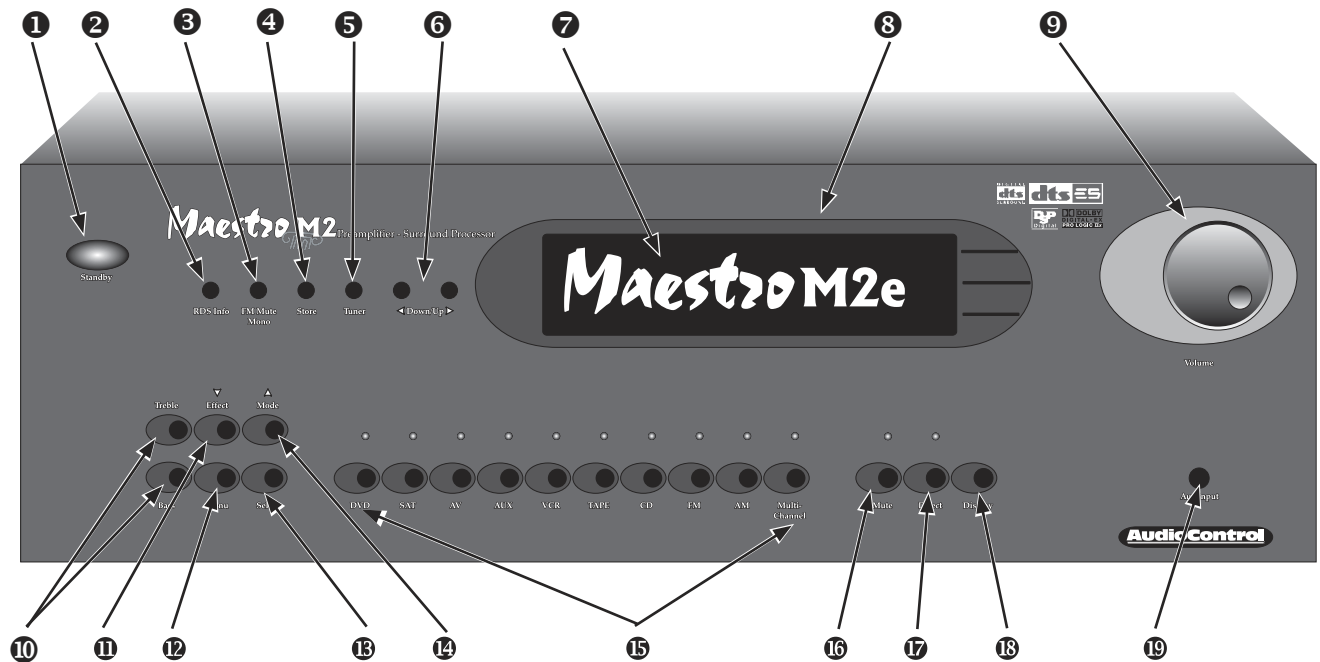

### Front Panel Features

- ❶ **Standby** – The switch serves to “wake up” your Maestro M2e, provided the main power switch, located on the rear panel, is turned on.
- ❷ **RDS Info** – Displays the RDS (Radio Data System) text information (ie. song name, artist, etc) provided the radio station selected is transmitting it.
- ❸ **FM Mute** – Engages auto-muting circuit which mutes weak FM radio signals.
- ❹ **Store** – Allows you to store your radio presets plus a good place to buy groceries.
- ❺ **Tuner** – Allows you toggle between the two tuning modes (Tune or Preset).
- ❻ **Down/Up** – Pressing these buttons allows you to scroll up and down through various stations. In the “Preset” mode these buttons scroll through the 30 FM stations or 10 AM stations stored in the preset memories of your Maestro M2e.
- ❼ **IR Remote Control Sensor** - Behind this display is the infrared sensor remote control. If the Maestro M2e is located in a system where this window is not line-of-sight with the main listening seat; a rear panel jack enables use of an outboard IR sensor.

- ⑧ **Function Display** - With the easy to follow menus, it is simple to operate and configure the Maestro M2e.
- ⑨ **Master Volume Control Knob** - In normal use, this knob is the volume control. When in the setup menus, turn this knob to select menus and options.
- ⑩ **Tone Controls** - By selecting Bass or Treble you can then use the “Master Volume” knob on your Maestro M2e to apply basic tone adjustments. For superior audio calibration adjustment we highly recommend you consider the AudioControl Diva, Digital Room Correction Processor.
- ⑪ **Effect** - These buttons allow the user to control the stereo audio surround modes or DSP effects for the various source units.
- ⑫ **Menu** - Tapping this button will allow you to access the Main Menu functions of the Maestro M2e. If you have the courage to push and hold this button for 2 seconds, it will allow you access to the Advanced Menu functions.
- ⑬ **Select** - Coincidentally enough, this button allows you to “Select” various modes or menu screens depending upon which function you are in.
- ⑭ **Mode** - When you are using source material containing Dolby Digital or DTS material, this button lets you cycle through the various surround modes available for each.
- ⑮ **Source Selection Buttons** - Simple enough, just press a button to choose what you want to watch or listen to.
- ⑯ **Mute** - Need to answer the phone, but still keep an eye on the TV? Just press the Mute button to turn off the sound. Press it again and the audio gracefully ramps back up to where you were so rudely interrupted.
- ⑰ **Direct** - For a two-channel analog input, this button defeats all digital signal processing and directs the two-channel analog input from the selected source to the front outputs. Use this button when you want to do some serious quality two-channel listening.
- ⑱ **Display Brightness Select** - This button toggles the display between two brightness levels or completely turns the display off. This is nice to get rid of distractions while you’re watching a good movie and the Maestro M2e is in your sight line.
- ⑲ **Aux Input** - Into this conveniently located jack, plug an external audio device like an MP-3 or even an iPod.

# Guided Tour of the Maestro M2e

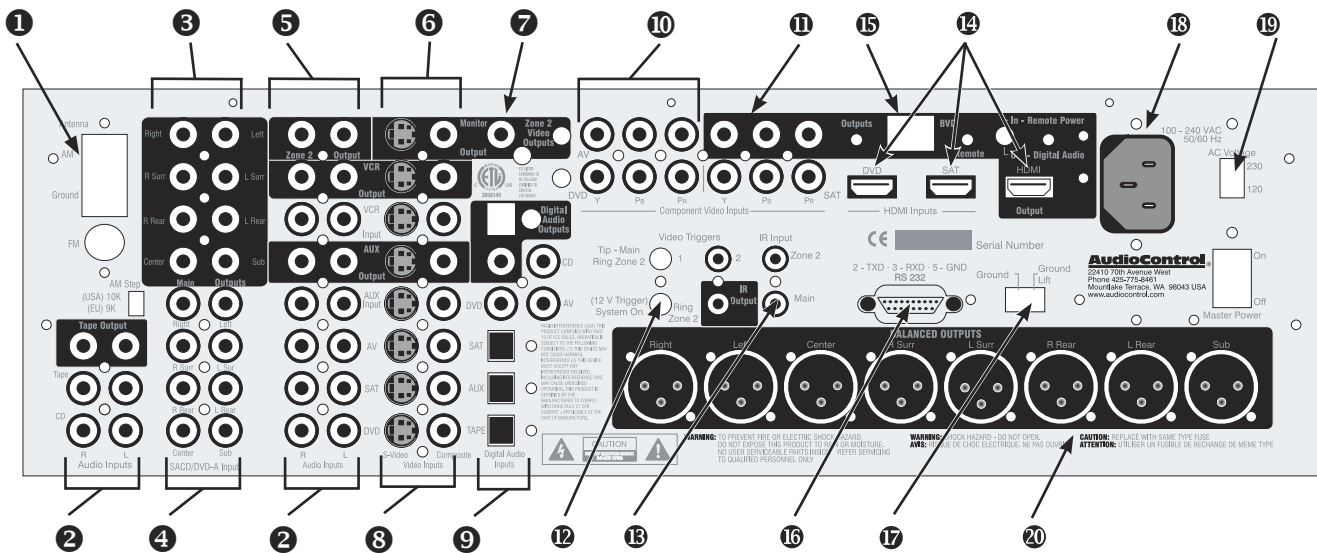

## Rear Panel Features

- ➊ ANTENNA CONNECTIONS – These inputs should be connected to the AM and FM antennas that are supplied with your Maestro M2e. For optimum reception you may want to consider a roof mounted external antenna.
- ➋ STEREO ANALOG AUDIO INPUTS AND OUTPUTS - Connect the appropriate two channel stereo outputs and inputs from your source units here.
- ➌ MAIN AMPLIFIER OUTPUTS – These unbalanced RCA outputs feed the main theater power amplifier(s). (Our customers tell us that our Savoy 7-channel amplifier is awesome. 😊)
- ➍ MULTI-CHANNEL DVD-A/SACD INPUT - Newer multi-channel audiophile recordings give you superb music audio quality in full surround. These players feature a surround decoder built into them. The Multi-channel inputs on the Maestro M2e bypass all digital circuitry and connect the player to the amplifiers with only a volume control in the path.
- ➎ ZONE 2 AUDIO OUTPUT - The second zone mains enables listening to a source independently of the main theater system.
- ➏ MAIN VIDEO OUTPUTS - Connect these Composite and S-Video outputs to your system's main video display or projector.
- ➐ ZONE 2 VIDEO OUTPUT - This is the Composite output for Zone 2. You must connect the Composite video input from each source unit to your Maestro M2e to make them available for this second zone output.
- ➑ COMPOSITE AND S-VIDEO CONNECTIONS - These are for the video inputs and outputs from your source units. If you are using the second zone video outputs, you should ALWAYS connect a Composite video input from each source, even if you are using a higher quality S-Video or Component signal for the main theater. Since these inputs are assignable you can rearrange the inputs if your CD player has a video output and your tape deck doesn't.
- ➒ DIGITAL AUDIO CONNECTIONS - The Maestro M2e features assignable Coaxial and Optical digital audio inputs and outputs. Don't worry if your satellite has a Coaxial digital output but the SAT connection on the back of the Maestro M2e is Optical as you can reassign the connection.

**Maestro M2e™ AudioControl®**

- ⑩ COMPONENT VIDEO INPUTS - Component video is one of the highest quality formats available. Use it whenever possible.
- ⑪ COMPONENT VIDEO OUTPUT - Connect these high quality video outputs to your main video display device (ie. Projector, CRT, LCD, etc.) You will be pleased to know that they will convert the Composite and S-video signals to the Component outputs of your Maestro M2e. See page 20 for more details.
- ⑫ 12 VOLT TRIGGER OUTPUTS - These three outputs provide a +12 volt signal to control the power amplifiers, source units, video projector, screens and curtains in the theater. The Main Trigger output is active whenever the Maestro is turned on; the Video Trigger 2 is active whenever a video source is selected.
- ⑬ IR REMOTE CONTROL CONNECTIONS - These jacks enable use of external IR sensors and emitters for installations where it is not desirable to use the front panel IR sensor.
- ⑭ HDMI INPUTS & OUTPUTS - These inputs allow the Maestro M2e to accept digital video signals from source units equipped with HDMI (High Definition Multimedia Interface) outputs. The Maestro M2e outputs digital signals via this HDMI output to a projection device with an HDMI input.
- ⑮ ACTIVE BALANCED OUTPUTS - This conveniently located RJ-45 connector outputs component video signals *PLUS* digital audio *OR* remote power that then runs to an optional AudioControl BVR-25 balanced line receiver. The switch next to the LED allows you to select between digital audio or remote power. Hint - Bright red LED means Remote Power. These outputs run in parallel to the Maestro M2e's standard component outputs so you will want to make sure that these component outputs (YUV) are activated in the General Settings menu (see page 25).
- ⑯ RS-232 SERIAL PORT - This connection is used to interface the Maestro with an external touch-screen or other automation system. It is also used when updating the internal Maestro M2e firmware programming.
- ⑰ GROUND LIFT SWITCH - In complex home theater systems, ground loops can be a painful fact of life. This button isolates the signal ground connections on the Maestro M2e from the AC Power ground. For safety reasons, the chassis remains earth grounded at all times.
- ⑱ MAIN POWER CONNECTION - All good AC power flows in here.
- ⑲ MAIN POWER SWITCH - Think of this as the vacation switch. You should only need to turn off your Maestro M2e with this button when the system will not be used for some time. Normally this button is left on and the Maestro M2e is "woken up" via the "Standby" switch on the front panel, via the optional remote control or through an automation system. When this switch is turned off, you cannot turn the Maestro M2e on or off via any other method.
- ⑳ BALANCED AUDIO OUTPUTS - These outputs send signals to amplifiers with balanced XLR type inputs. This type of configuration yields maximum noise rejection from the airborne interference and is recommended for applications where you are sending audio signals over a long distance.



## Set-Up & Configuration

### Unit Placement

The Maestro M2e can be placed almost anywhere in your audio equipment stack as it only generates a small amount of heat during operation. It is good practice to ensure that the equipment location is properly ventilated and to make certain not to block the ventilation slots on any other component. Avoid placing Maestro M2e directly over large power amplifiers. Unless they are made by AudioControl, some amplifiers can get pretty hot and have big power transformers that can induce hum into other audio components like Maestro M2e. Make certain that there is an unobstructed line-of-sight between the location where the remote controller sits and the Maestro M2e front panel.

### Speaker Considerations and Placement

Choosing the right speakers and putting them in the correct positions is crucial to getting the most out of a home theater system. For the full THX surround EX playback experience, we recommend two speakers placed behind you. Once you have decided on the speakers you are using, make certain the Maestro M2e is configured to match your speakers.

#### Front LCR (Left, Center, Right) Speakers

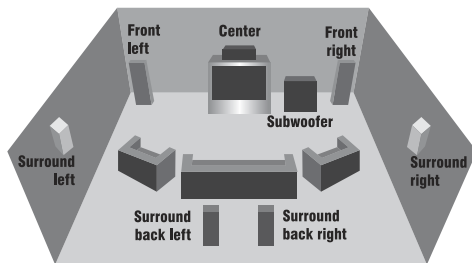

To present the most realistic soundstage, all three of the front speakers must be tonally balanced. Ideally, these speakers should be identical models. This ensures that the sound doesn't change as it pans across the screen. Place the speakers at the seated ear level. Whenever possible, the three front speakers should also be placed at the same horizontal level for best imaging.

## Side Surround Speakers

The surround speakers provide the reverberant, or ambient, sound effects in a multi-channel theater audio system. These speakers should be placed on the side walls approximately 36" above the seated ear height of the listeners. If you are using surround speakers which have a dipole sound pattern they should be mounted in-line with the main seating position. If the surrounds are direct radiator, they should be just behind the main listening seat.

## Rear (Back) Surround Speakers

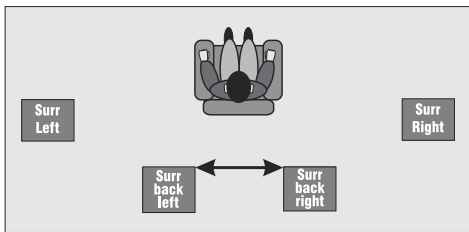

Some software provides extra channels that are used in 7.1 mode systems to provide extra depth in the soundfield. Place these speakers approximately 36" above the seated ear height of the listeners. Additionally, they should be mounted close together (less than 12" apart) on the rear wall of the theater facing the screen. If you must place the speakers further apart, make certain to change the Advanced Speaker Array setting in the set up menus.

## Subwoofer

The subwoofer is a large speaker that provides the bottom end "kick" in the system. Depending on the size of your listening space, you may require more than one subwoofer to get the bass volume levels that you desire. Make certain you remember to include the size of all spaces that are open to the theater in determining harmony subwoofers you need.

### Connection Tips

Even if you're an electronics veteran, this part may seem repetitive, but some things can never be repeated too many times.

- Turn off all components before making any connections.
- When making connections, make sure that "left goes to left" and "right goes to right." The obvious and time-honored way to assure this is to assign RED plugs to Right and WHITE/GREY/BLACK plugs to the left. Yellow is usually used for video cables or digital audio connections.



- Wherever possible, keep power cords away from signal cables (i.e., inputs from disk players, VCRs, etc.) to prevent induced hum. Bundle all power cords down one side of your equipment cabinet and all the signal cables down the other.
- Use high quality interconnect cables. We're not going to get into the debate about whether \$100 per meter interconnects improve the sound and picture quality of your system. We do know from experience however that really, REALLY cheap connections can cause problems.
- Don't stand in a bucket of water when working with electricity.

### Power Wiring

Like many of today's intelligent home electronics, the Maestro M2e should be plugged into an unswitched AC outlet so that it always has power. This allows the RS-232 and remote control features to work even when the Maestro M2e is in standby. We always recommend the use a high quality surge protection device to keep all of your electronics safe from the evils of spikes on power systems.

### Audio Connections

Most of the sources will have two audio connections to the Maestro M2e; the 2 channel *analog* audio and the multi-channel *digital* audio. When given the option, you should connect both types of audio signals to the Maestro M2e. This will provide the digital audio signal necessary for high-quality digital surround sound along with the analog audio for tape recording and the second zone audio output.

Don't worry if your satellite receiver has a coaxial digital output and the Maestro M2e SAT input is optical. Refer to the advanced configuration section on page 30 of this manual for more information regarding assigning a digital input to the optical or coaxial connection.

# Set-Up & Configuration

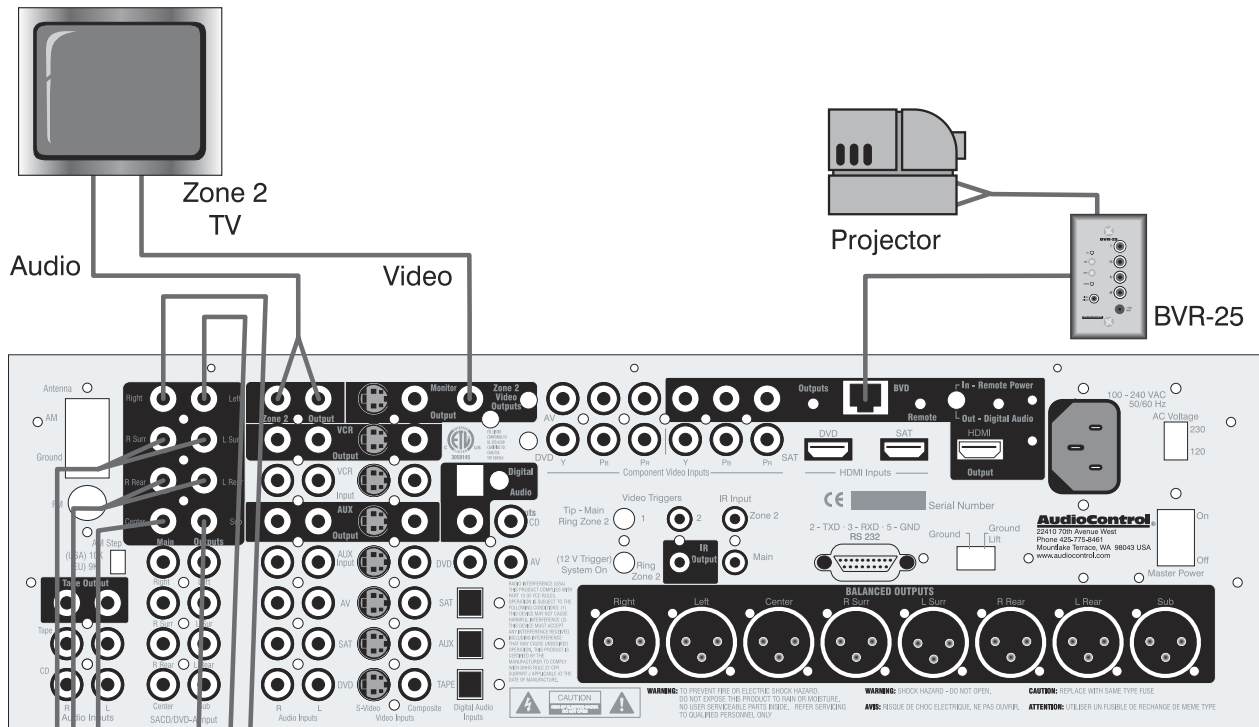

## Maestro M2e™

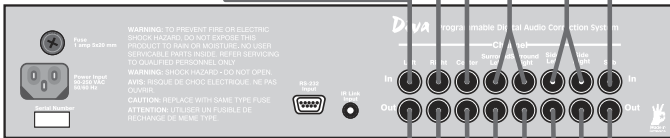

**Diva**  
Audio Enhancement Processor

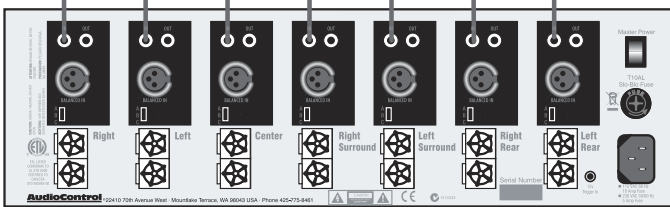

**Savvy**  
7 Channel Amplifier

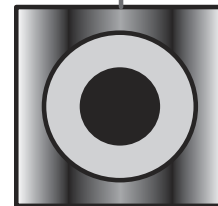

Subwoofer

# Maestro M2e™ AudioControl®

Phone 425-775-8461 • Fax 425-778-3166

## Multi-Channel Analog Audio

Audiophile surround recording formats such as SACD and DVD-A decode the multi-channel signals directly within the player. The Maestro M2e features an 8 channel direct analog input for these sources. These inputs bypass the digital circuitry in the Maestro M2e and are routed directly to the Main Amplifier outputs via an independent volume control circuit. This ensures the highest possible audio quality for this input.

## Video Connections

### Choosing your video

Types of video connections

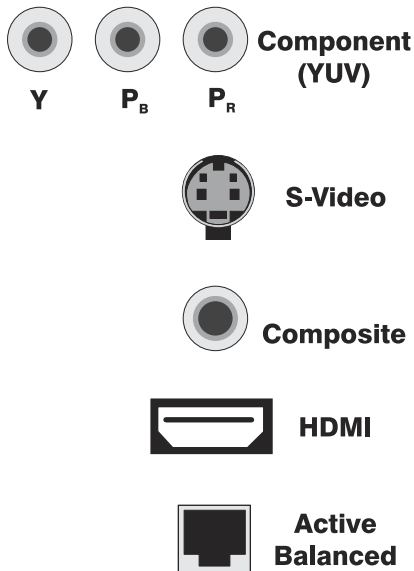

There are four video signal connection formats ranging from Composite (Good), S-Video (Better), HDMI digital video, Active Balanced and Component (Best). Depending on the particular source unit, you may have the option of more than one of these video connections. Always choose the highest quality video output available on your sources. Because of the higher bandwidths involved with video signals, the quality of the interconnect cables you choose is important. Video connections should always be made with cables specifically designed for video. Don't be tempted to grab some extra audio RCA cables laying around. Without the proper 75 ohm cabling, your picture quality will suffer from smear, ghosting or noise. It is always a good idea to make certain that the video and audio signal cables are routed away from any power wiring.

### Component, Composite and S-Video

To ensure the highest quality video signal you always want to run the best video format from each source unit to your Maestro M2e. For example, if your DVD player has Component and Composite video outputs, use the Component connection. Should you wish to route the video to Zone 2 then you need to also run Composite connections.

## Active Balanced Video Outputs



If you are running your video signals a long distance (i.e. greater than 50') than you should consider the Active Balanced Output on your Maestro M2e. This RJ-45 connector uses CAT-5 wiring to send a signal to an optional AudioControl balanced line receiver, such as the BVR-25 or BVR-20. Additionally the CAT-5 can also transmit a digital audio signal or provide remote power for the BVR-25. The switch conveniently located next to the RJ-45 connector allows you to select the proper output configuration.

For reference, AudioControl's Active Balanced Technology is based on the balanced signal distribution format, which is the standard in the professional video and audio environments. Because of their design, balanced transmissions inherently reject the vast majority of hum, noise, or distortion introduced along the signal path. Additionally, the Active circuitry used in AudioControl's products allows high quality video and audio strength to be maintained over longer distances than traditional passive devices.

## Video Transcoding

To simplify your installations, the Maestro M2e provides video transcoding which routes the S-video and composite signals to the Component outputs of your Maestro M2e. The following video translation is available:

OUTPUTS				
INPUTS	COMPOSITE	S-VIDEO	COMPONENT	ACTIVE BALANCED
COMPOSITE	Yes	Yes	Yes	Yes
S-VIDEO	Yes	Yes	Yes	Yes
COMPONENT	No	No	Yes	Yes

High quality conversion between the various video signal connection formats is a tricky thing and best left to dedicated video processors.

### HDMI Signals

The HDMI inputs and outputs on your Maestro M2e accept digital video signals.

### Input Configuration

The Component video inputs are fully assignable to the sources. This allows you to configure the Maestro M2e to accept the video input from a particular source unit on one of the three Component video inputs.

### IR Remote Control Connections

Since the Maestro M2e is often hidden away in some dark closet or equipment rack, we have provided connections for external IR remote control receivers and emitters. This allows you to place the infrared receiver where it can “see” the signal from the remote control. The Zone 2 IR input controls the second zone functions of the Maestro M2e and also repeats commands to the source units through the emitter output.

The IR receiver input connections are wired with a 3 conductor 3.5mm jack. The signals are compatible with third-party receivers such as a Xantech No. 291-10.

AudioControl does not supply the IR receivers or emitters to use with the Maestro M2e.

TIP	IR Signal
RING	Ground
SLEEVE	Current Limited +12 VDC (30 mA max.)

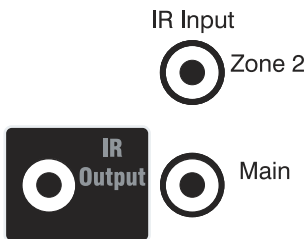

## 12V Trigger Connections

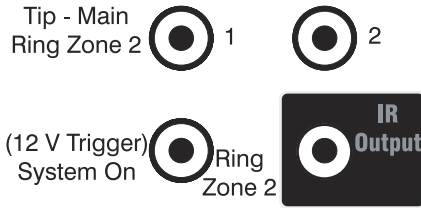

Video Triggers

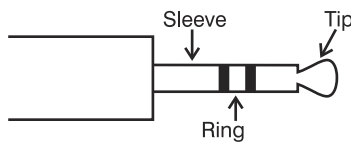

Picture of a 3.5mm stereo mini-jack connector

There are three stereo mini-jack 12 volt trigger outputs on the rear panel of the Maestro M2e which are used to remotely control such things as the power amplifier turn-on, projector power, screens or curtains. The “System On” Trigger has two separate outputs. The jack is a three conductor; Tip, Ring, Sleeve connection.

- TIP Main Zone On (12V, 30mA)
- RING Second Zone On (12V, 30mA)
- SLEEVE Ground (0V)

The two video triggers carry one signal each. Video Trigger #1 has 12 volts DC when the Maestro M2e is turned on. Video Trigger #2 jack goes to 12 volts when one of the video sources is selected and is generally only used with European (SCART) video devices.

The Main “System On” Trigger would generally be used to control the power to the amplifiers and source units. The Video Trigger would be used to control the projector or video screen.

**Note: Do not use a mono mini-jack as you will not make the proper connections.**

## Second Zone Connections

The Zone 2 outputs on the Maestro M2e send an independent audio and video signal to a second room. There is a 2 channel stereo analog audio output and a composite video output.

There is also an IR sensor input for the second zone. This enables you to remotely control the Maestro M2e and also repeats the IR to your source units through the IR Output jack on the Maestro M2e. Any IR signal received through the Maestro M2e’s front panel IR sensor or through an IR sensor connected to the IR inputs is repeated to the IR Output for controlling the source components in your system.

Since the Zone 2 outputs of the Maestro M2e are 2 channel analog audio and composite video, you must have these signals connected from your source units to make them available. The Maestro M2e does not convert a digital audio signal into analog for zone 2.

## Navigating the Main User Menus

Selecting around the Main Menus is a very simple and intuitive feat.

1. Press the Menu button to enter the Main Menu Screens.
2. Rotate the Multi-Function Knob to select Menu 1, 2 or 3.
3. Press the ▼ (Mode) and ▲ (Effect) buttons to select the menu options.
4. Use the Multi-Function Control Knob to step through the setting options.
5. Press the Menu button to exit the Main Menu Screens.

### Main Menu Screen 1 – Inputs and Volume

```

Main Menu Screen 1
Vol:
----I----- 29dB
Audio Input:FM
Video Input:VCR
Video Type:4.3
Stereo Direct:On
Bass          N/A
Treble        N/A
Bal:  - - - - -I- - - - - 0dB
    
```

VOLUME: Allows adjustment of the Main zone volume while in the Menu Screens.

AUDIO INPUT: Selects the currently active audio source input.

VIDEO INPUT: Selects the currently active video source input.

VIDEO TYPE: This setting is only applicable to TVs being fed a SCART signal, typically only used in Europe.

STEREO DIRECT: Enables the Stereo Direct mode. This is the same as pressing the Direct button.

BASS AND TREBLE TONE: Adjusts the tone control of the front Left and Right channels.

BALANCE: Adjusts the left/right balance of the front outputs.

### Main Menu 2 – Audio Settings

```

Main Menu Screen 2
Compression:  Off
Lyp Sync.:    +00ms

Pro LogicII Music Mode:
Dimension:    +3
Center Width: +3
Panorama:    0
    
```

COMPRESSION: Compressing the dynamic bandwidth of the audio can be a good thing, especially for those late night action movie festivals. Compression increases the volume of quiet sections and reduces the volume of the louder sounds.

There are three settings for the compressing:

Off: No Compression

Medium: Just a little off the top

High: Keeps the sound down and won't wake the kids.

LIP SYNC: Many video processors and line multipliers cause a slight delay between the sound and the video picture.

Highly compressed video signals such as MPEG encoded

satellite receivers and some DVD's also suffer from this problem. The Lip Sync setting delays the audio a small amount to allow the video image to catch up.

**PRO LOGIC IIX MUSIC MODE:** Pro Logic II/IIX provides a more detailed surround decoding from two channel analog audio sources than the previous Pro Logic modes. There are several adjustments to get the best sound imaging from the ProLogic II/IIX mode:

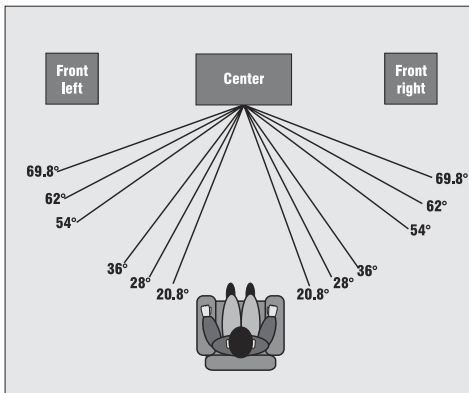

**DIMENSION –** Adjusts the depth of the front/rear soundstage.

For normal listening this should be set to +3. If you find the sound too spacious, turn this setting towards 0, if the sound is flat and you want more depth from front to rear, turn the adjustment up towards +6.

**CENTER WIDTH –** Determines how strongly the Pro Logic II decoder processing creates the center channel image. Normally this signal is fed only to the center channel speaker output, but if the center speaker is set to "None" in the speaker setup, a phantom center channel is created from the front left and right channels. Normally this setting is left at +3.

**PANORAMA MODE –** When the Panorama Mode is enabled, the front center image is extended to include the rear surround speakers. This provides a more enveloping wrap-around effect.

## Main Menu 3 – Zone 2 Settings

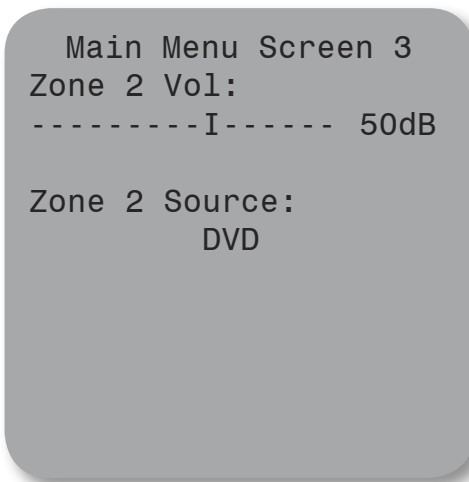

**ZONE 2 VOL:** Controls the current volume on the Zone 2 audio outputs.

**ZONE 2 SOURCE:** These options allow listening to a different source on Zone 2 than on Zone 1.



## Advanced Setup Menus

### Entering the Setup Mode

Setup Menu Index	
Basic	Advanced
1.General	1.Speaker EQ
2.Spkr Size	2.Video
3.Subwoofer	3.Digital
4.Delays	4.Zone 2
5.Level Set	5.Input Trim
6.EX	6.HDMI
Save Setup	Exit Menu

To enter the System Setup menus: Press and Hold the Menu button for at least two seconds. The main "Setup Index will be displayed on the Maestro M2e and the video display connected to the Main Video Outputs. Please note that it is easiest to go through the advanced set-up menus when the Maestro M2e is connected to a video display device so all menu options are shown.

### Navigating the Setup Menus

Once you have entered the Setup Menu Index:

1. Use the arrow buttons ▲ (Mode) and ▼ (Effect) to step through the menus.
2. Use the Volume Control Knob to go between "Basic" and "Advanced" menu items
3. Use the "Select" button to pick a menu item
4. Use the Volume Knob to step through the setting options.
2. When finished, press the Menu button.
3. Use the Volume Knob to choose Save or Exit with Saving
4. Press Select to choose the option and exit the setup menu.

## Configuring The Maestro M2e

### 1. General Settings

1. General Settings  
Max Volume: 100  
Max On Volume: 70  
  
Delay Units: Time  
OSD Mode: Full Page  
Video Status:SCRN CTRL  
HQ Video: YUV

**MAX VOLUME** - This limits the highest volume that the Maestro M2e will play. This is useful if you have speakers or amplifiers of limited power handling abilities.

**MAX ON VOLUME** - This is the highest volume that the Maestro M2e will play when first turned. This prevents the Maestro M2e from being turned on at shock volume levels from the last time you were watching a good movie.

**DELAY UNITS** - The settings can be adjusted in English (Inches), Metric (Centimeters), or Time (milliseconds). Important Installation Note: When you change the Delay Units, all delay settings are returned to "0". Make certain you choose your preferred units BEFORE adjusting the delays.

**OSD MODE** - The On-Screen Display (OSD) can be displayed in either Mixed mode where the white text is overlaid onto the video image, or in Full Page mode where the video image is temporarily replaced with a black background.

**VIDEO STATUS** - Sets the operation of the 12 volt trigger outputs. For normal operation, leave this set to Screen Control as it enables the Main and Video Trigger outputs to operate for equipment control triggers. The SCART option is only used on European video equipment to control external video switching and scan-rate converters.

**HQ VIDEO** - Choose the operation of the OSD to match your video projector or display. Typical high-end video systems use YUV (aka Component Video (Y, P<sub>B</sub>, P<sub>R</sub>)) for their signals. Don't confuse the colors on the RCA cables used to connect the video equipment with the format. Many Component video cables have their connectors colored red, green and blue even though they are not sending an RGB signal. The RGB (Red, Green, Blue) signal format is more common in Europe.

## 2. Speaker Sizes

### 2. Speaker Sizes

Auto Setup: Config1

Front L/R: Small

Centre: Small

Surr L/R: Small

Surr.Back L/R: Small

Sub Woofer: Present

5.1 Rears: Both

For the purposes of setting the Maestro M2e, a "Large" speaker is one that is capable of reproducing a full range (20-20KHZ) audio signal. A "Small" speaker is one that cannot reproduce deep bass frequencies (i.e. typical Satellite speakers typically below 80 Hz). If you do not have a speaker connected to an output (i.e. No Subwoofer or Back Speakers) then set that speaker size to "None".

**AUTO SETUP** - Allows quickly setting common speaker size configurations based on the following:

Speaker	Config 1	Config 2	Config 3	Custom
Front L/R	Small	Large	Large	Sm/Lge
Center	Small	Small	Small	Sm/Lge/None
Surr L/R	Small	Small	Large	Sm/Lge/None
Surr Back L/R	Small	Small	Small	Sm/None
Subwoofer	Present	None	Present	Present/None
5.1 Rears	Both	Both	Both	Surr L/R Surr Back L/R/Both

CONFIG. 1, 2, AND 3 - These are standard speaker combinations for home theater systems.

CUSTOM - This gives you full control over each speaker channel.

5.1 REARS - This defines how a 7.1 channel installation will utilize the surround speakers.

SURR L/R - Sends all of the decoded surround information to the Surround Left/Right outputs. No audio is sent to the Back outputs.

SURR BACK L/R - Sends the surround audio to the Back outputs and nothing is sent to the Surround outputs.

BOTH - Sends the same decoded surround audio to both the Surround and Back outputs (the surround level is automatically reduced 3dB).

### 3. Subwoofer Settings

#### 3. Subwoofer Settings

Stereo Mode: Large  
Cross-Over Freq: 80Hz

Sub Stereo: -----I 0dB  
DTS LFE Gain: 0dB Normal

7.1 Sub Level:  
0dB Normal

STEREO MODE - This controls how the subwoofer operates in the Stereo music modes.

LARGE: All of the stereo audio is passed to the Left and Right Outputs. Nothing is sent to the Subwoofers.

LARGE + SUB: Same as above, but bass is also sent to the Subwoofer. This provides additional punch to the bottom end.

SAT + SUB: Provides full bass management when you are using smaller satellite-type front speakers. The lower bass frequencies are cut off from the Left and Right Outputs and sent to the Subwoofer Outputs.

CROSSOVER FREQUENCY - This controls the frequency at which bass is redirected from speaker channels set to "Small" and sent to the Subwoofer outputs. This frequency is adjustable from 40 Hz to 130 Hz in 10 Hz increments.

SUB STEREO - This adjusts the relative level of the subwoofer channels in the Stereo Music modes. Your personal tastes should be the guideline for this adjustment after the other levels have been properly calibrated.

DTS LFE GAIN - Older DTS soundtracks have a LFE (subwoofer) soundtrack recorded 10 dB lower than Dolby Digital. The -10dB setting boosts the DTS LFE soundtrack to the same as other formats. The 0 dB setting leaves the DTS LFE channel unaffected.

7.1 SUB LEVEL - The decoded subwoofer output channel of a DVD-A player is typically 10 dB lower than the other channels. The +10dB option boosts the subwoofer signal by 10dB. The 0dB passes the subwoofer channel unaffected.

## 4. Delay Settings

### 4. Delay Settings

Front Left: 0.0ms  
 Center: 0.0ms  
 Front Right: 0.0ms  
 Surr. Right: 0.0ms  
 Surr. Back Right: 0.0ms  
 Surr. Back Left: 0.0ms  
 Surr. Left: 0.0ms  
 Subwoofer: 0.0ms

The Speaker Delay settings help the sound from each speaker arrive at the listening seat at the same time. This provides a much more believable and immersive sound environment. Precise delay settings should be done by a trained professional with audio test equipment such as the AudioControl Iasys HT to measure the actual sound delay.

You can get a rough delay setting using an assistant and a tape measure. Measure the distance from the center of a speaker to the seated ear position of the main listening seat. Write each of these distances down and enter them into the Maestro M2e.

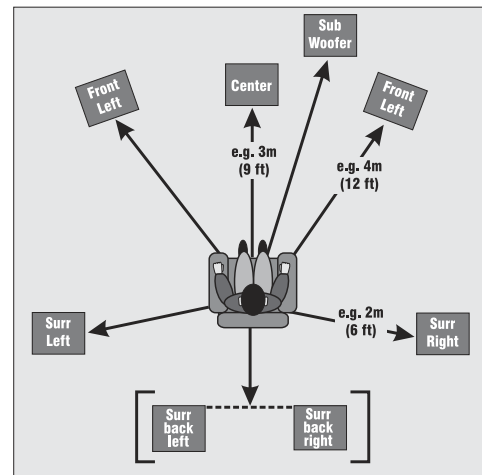

## 5. Level Settings

### 5. Level Settings

Test Tone Cycle: Manual  
 Front L: ---I--- 00dB  
 Center: ---I--- 00dB  
 Front R: ---I--- 00dB  
 Surr. R: ---I--- 00dB  
 Surr. BR: ---I--- 00dB  
 Surr. BL: ---I--- 00dB  
 Surr. L: ---I--- 00dB  
 Subwoofer: ---I--- 00dB

It is critical to properly match the levels from each speaker to achieve a correct sound stage. The realism is totally lost if the footprints of a person walking across the screen change in volume as they move from left to center to right. We strongly recommend using a test analyzer such as our IasysHT for this calibration. The levels are nearly impossible to judge by ear alone. Though not as accurate as using the Iasys HT, you can use a sound level meter for this adjustment.

With the internal test noise generator of the Maestro M2e, adjust each speaker for a sound pressure level (SPL) of 75 dB using a "slow" response time on the SPL meter placed at the main listening position at ear height. Use the Mode and Effect buttons on the Maestro M2e to select a speaker chan-

nel, then adjust the volume of that speaker with the Multi-Function control knob.

The Test Tone Cycle setting is normally used on Manual. The Automatic option is used for a quick check by ear after you have manually calibrated the levels. The Automatic option steps through all the speakers with a two second burst of test noise. Sitting in the main listening position, adjust the individual channel setting so that you do not hear any change in volume level as each speaker is played.

### 6. EX Settings

6. EX Settings  
Surr. EX: Manual  
Use Channels 6+7 For:  
DD Surr EX

**SURR. EX:** When playing Surround Ex encoded material, the Maestro M2e gives you the option of either Manually(Manual) or Automatically(Auto) selecting the Surround settings.

**AUTO DD EX -** The Maestro M2e will automatically switch to Surround Ex decoding when Surround EX material is detected. Set this option to Manual if you want to control which mode is used by the Maestro M2e.

**AUTO PLIIx MOVIE -** The Maestro M2e will automatically switch to Pro Logic IIx Movie decoding when appropriate material is detected. Set this option to Manual if you want to control which mode is used by the Maestro M2e.

**MANUAL -** The Surround Ex mode can only be selected using the optional AudioControl MX-500 remote control or via the RS-232 port.

**USE CHANNELS 6+7 FOR:**

**DOLBY DIGITAL SURR EX -** In this mode, amplifier channels 6 and 7 drive the two additional rear EX speaker channels

**BIAMP L+R -** This mode allows you to bi-amplify your front speakers which, with the addition of additional amplification, helps you improve the performance of these speakers.

## Advanced Setup Menus

Adv1 - Speaker Eq  
Bass            Treble  
All--I-- 0dB --I-- 0dB  
FL --I-- 0dB --I-- 0dB  
C --I-- 0dB --I-- 0dB  
FR --I-- 0dB --I-- 0dB  
SR --I-- 0dB --I-- 0dB  
SBR--I-- 0dB --I-- 0dB  
SBL--I-- 0dB --I-- 0dB  
SL --I-- 0dB --I-- 0dB  
AUTO Tone Bypass: Yes

### ADV 1 - Speaker Eq

CHANNEL EQUALIZATION - For simple tone control, we have included Bass and Treble adjustments on the Maestro M2e for each channel with 6 dB in boost or cut. To get the best performance from a home theater system, we strongly recommend the use of a good equalizer such as our Diva.

AUTO TONE BYPASS: - Set this option to Yes to automatically defeat the above tone control settings when in the Stereo music mode.

Adv2-Video Settings  
Zone 1 OSD: On  
Video Input Tape: None  
Video Input CD: None  
Video Input FM: None  
Video Input AM: None  
Video Input DVD-A: DVD  
Input:            Button:  
HQ Vid DVD: DVD  
HQ Vid AV : AV  
HQ Vid Sat: SAT

### ADV 2 - Video Settings

ZONE 1 OSD: - Controls the display of the On-Screen Display.

ON: All volume control, source selection and setting options are displayed on the main video outputs.

OFF: Only the Main and Setup menus are displayed.

ASSIGNING COMPOSITE AND S-VIDEO INPUTS: - Allows for advanced video settings and specifically for assigning a video input to a source with no actual video output. You can assign DVD, SAT, AV, Aux, or VCR to any of these audio inputs or select None.

Adv3 - Digital Settings  
Coaxial inputs  
Input: Button:  
DVD: DVD  
CD: CD  
AV: AV  
Optical inputs  
Input: Button:  
SAT: Sat  
AUX: VCR  
Tape: Tape

ASSIGNING COMPONENT VIDEO INPUTS - The HQ Video option lets you assign audio sources to the high quality component video inputs. Select the source input you want associated with each of the component video inputs.

### ADV 3 - Digital Settings

ASSIGNING THE DIGITAL AUDIO INPUTS - The Digital Audio inputs on the Maestro M2e are fully assignable. Any digital input can be assigned to any source selection. Only one source can be assigned to a digital input. When planning your installation you should identify whether each source unit has a Coaxial Digital, Optical Digital or No digital output.

```
Adv4 - Zone 2 Settings
Zone2 Vol:
-----I----- 36dB
Max Vol 20-83: 83
Fix Vol:      No
Max On Vol:   50
Standby: Local Only

Access: ALL
```

### ADV 4 - Zone 2 Settings

**MAX VOLUME** - This works just like the Main Zone maximum volume setting back in the basic menus. It limits the maximum volume control setting for the Zone 2 output.

**FIXED VOLUME** - If you are using the Zone 2 output from the Maestro M2e to feed into another stereo receiver in the remote zone, you will want to set this option to Yes. This provides a constant signal level so you can use the volume control on the receiver in the second zone to control it's volume. Install Hint: Set the desired output volume level for Zone 2 with the volume control before setting this option to on. The Maestro M2e locks the Zone 2 output at the current volume setting when this option is set to on.

**MAX. ON VOLUME** - Sets the maximum volume that the Zone 2 output will play when the power is turned on.

**STAND-BY** - Allows Main Zone (zone 1) to be put into stand-by either locally or by zone 2.

**LOCAL ONLY** - Only the main zone switches into stand-by from main zone

**ALL OFF** - Both the main zone and Zone 2 can be switched into stand-by from the main zone.

**ACCESS** - Limits which sources are available to Zone 2. To set this option: Press the source input buttons to toggle a selection on or off using the optional remote control.

### ADV 5 - Input Trims

**Adjusting the Source Unit Input Volume Trims** - The input trims allow the installer to match the relative volumes of all sources so when you switch from one source to another the relative volume level will be balanced. These trims affect only the two channel analog audio inputs from each source. There is no change to the digital audio levels.

The available output options are Low .5V, Medium 1V, Reference 2V and High 4V. The reference 2 volt setting should be appropriate for most sources. To set the levels for a source, select a loud music selection or use a 0dB reference disk and switch between sources. If one source is noticeably louder or quieter than others, make the appropriate level settings to that source.

### Adv5 - Analogue Settings

```
DVD:   Low 0.5V
Sat:   Low 0.5V
AV:    Low 0.5V
AUX:   Low 0.5V
VCR:   Low 0.5V
Tape:  Low 0.5V
CD:    Low 0.5V
```

## Adv6 - HDMI Settings

Input:	Button:
DVD:	DVD
SAT:	Sat

## ADV 6 – HDMI Settings

The HDMI switching on the Maestro M2e is strictly for routing digital video signals so you will need to assign an audio input to each of the HDMI digital video inputs that you are using. This will allow the user to enjoy the highest possible audio and enables the installer to change the source input names for the front panel and on-screen displays.

## Saving Settings and Exiting Set-up

### Setup Menu Index

Basic	Advanced
1.General	1.Speaker EQ
2.Spkr Size	2.Video
3.Subwoofer	3.Digital
4.Delays	4.Zone 2
5.Level Set	5.Input
Trim	
6.EX	6.HDMI
Save Setup	Exit Menu

Once you are done editing your set-up menus you should now save your settings and/or exit the Set-Up menu.

1. Press the "Menu" button
2. Turn the volume knob to select between "Exit Setup" and "Save Setup"
3. Press the "Select" button



## Operating the Maestro M2e

Now that you have everything connected together and configured properly, it's time to sit back and enjoy the fruits of your labor. Since the Maestro M2e gives you two independent "zones" to view and listen to your system (the Main home theater zone and the remote Zone 2) we'll cover them separately. The primary difference between the two zones is that there is multi-channel surround sound for the Main zone and two channel stereo in the second zone.

### Main Zone

All operation of the Maestro M2e can be done with either the front panel display or the On-Screen Display (OSD) on the video display. The OSD is simpler to use since the larger display allows all the menu options to be listed at once.



### Turning the Maestro M2e On

There is actually two levels of turning the Maestro M2e on. First, the rear panel Power switch button must be selected. This turns on the AC power to the Maestro M2e. In most systems this power switch will ALWAYS be left on so the theater automation system can control the Maestro M2e. When the Maestro M2e receives a power off command from the IR or RS-232 inputs it goes into a sleep Standby mode. The Maestro M2e is a very light sleeper and will wake back into normal operation by pressing any source input button or sending a "power on" command to the IR or RS-232 inputs.

### Choosing your Input Using the Main Menu

The three Main Menus of your Maestro M2e enable the user to make basic changes in the operation of the Maestro M2e.

### Choosing your Input

The Source selection buttons beneath the main Maestro M2e display choose the source component that you want to view or listen to. There are ten sources available on the Maestro M2e. When configuring the Maestro M2e, there are several options to reassign the digital audio and video inputs to different sources.

### Simulcast Listening

It is simple to choose separate audio and video sources with the Maestro M2e which allows you to watch one source and listen to the audio from another. From the Operation screen on the Maestro M2e

1. Press the Menu button to enter the Main Menu Screen 1: Inputs and Volume.
2. Press the ▼ (Effect) until you see Audio Input.
3. Press a Source Button to choose the Audio input source.
4. Press the ▼ (Effect) again and you will see Video Input.
5. Press a Source Button to choose the Video input source.
6. Press the Menu button to exit the Main Menu Screen 1.
7. These input selections will stay in effect until you press a Source Button to choose another source. The Video input will automatically return to tracking the Audio source.

### VCR and Tape Operation

The Maestro M2e has full independent recording loops for a VCR and Tape Deck. Both of these inputs allow recording separately from the one that you are listening to. Pressing the Tape button while another source is active enables you to continue recording that source, but monitor the output of the recording deck. Both source LEDs on the front of the Maestro M2e will be lit.

## Stereo Direct

For two-channel analog listening, the Maestro M2e features a Stereo Direct input mode. This mode defeats all digital processing and passes an analog direct two channel audio signal from the input source to the main amplifier outputs of the Maestro M2e. Most of the digital circuitry in the Maestro M2e is bypassed when in the Stereo Direct mode.

## Setting the Surround Modes

When listening to a source, the Mode button toggles between the available Surround Decoding Modes (Mono, Stereo, Pro Logic II, DTS Neo, Dolby Digital, etc.). The modes available will change depending on the source materials encoding. Refer to the manual section on Surround Modes for more details about each mode.

## DSP Effects

The Maestro M2e isn't all work and no play. When listening in the "Stereo" mode, the Maestro M2e features several DSP effect modes to simulate different listening environments. These effects provide varying amounts of delay and reverberation so your theater will sound completely different. Try them out at your next party. Refer to the manual section on Surround Modes on page 42 for more details about the DSP effects.

Effect	Description
None	No effects active, stereo signal
Music	Extracted ambience and center information
Party	All speakers on
Club	Small room
Hall	Medium reverberant room
Sport	Very reverberant with extracted ambience and dry center dialog
Church	Long reverberant room

### Display Brightness

Because everybody has different preferences in how the equipment in their home theater should look, we have provided a control over the brightness of the main Maestro M2e display. This button toggles between three display levels: Bright, Dim and Off. In the Off mode, the display will momentarily come on when any button is pressed or the volume is changed and then return to the blank off state

### Second Zone

The Zone 2 outputs provide a means for listening and viewing your home theater components in another room. The source selections and volume control for this second zone is independent of the main theater zone outputs. There are several options for controlling the second zone: The Main Menu screen from the Maestro M2e, the external RS-232 serial control port, or the IR remote control.

The Zone 2 video output has an On-Screen Display and setup menu independent of the Main video outputs. This screen displays the current source selection status for Zone 2 along with the current Zone 1 settings. Depending on the Advanced Zone 2 settings in the Maestro M2e configurations, you may not be able to change the Zone 1 settings from Zone 2. See page 21 for more detailed information.

### Surround Modes

The Maestro M2e theater processor contains a powerful digital signal processor (DSP) that enables the Maestro M2e to decode multiple digital and analog multi-channel surround sound formats. Since the Maestro M2e is fully programmable, new surround decoding formats may be incorporated as they become popular.

There are two types of surround processing modes in the Maestro M2e for both digital and analog source material. These are selected using the Effect and Mode buttons on the front panel or their equivalent commands in the external control protocols. The Effect button selects special DSP processing effects for two channel analog sources only. The Mode button manually selects the surround decoding mode when the source media does not automatically configure the Maestro M2e.

There are two different music surround playback methods: Those that use the internal digital decoding of the Maestro M2e (Dolby Digital or DTS encoded) and the newer multi-channel audiophile Super Audio CD (SACD) and DVD-Audio formats that have the decoding built into the players. The SACD and DVD-A formats bypass all internal processing in the Maestro M2e and feed directly to the amplifiers through the volume control. Since the digital processing in the Maestro M2e is defeated, there are no mode adjustments available. The Dolby Digital and DTS encoded music disks are treated the same as surround encoded movies and have the same options.

### Modes for Digital Source Material

Digital surround recordings have details of their decoding requirements encoded into the media. The Maestro M2e automatically detects this information and switches to the appropriate surround mode.

The following modes are available for multi-channel digital sources. Special modes such as DTS ES and DTS 6.1 Discrete are only available from properly encoded source materials.

### Dolby Digital 5.1

This is the most commonly used surround format for DVD, Digital Satellite and Broadcast television. Dolby Digital 5.1 delivers surround sound with five discrete full-range channels and a low frequency bass effects (LFE) subwoofer channel.

### DTS 5.1

The DTS 5.1 mix is less common than the Dolby Digital format, although it is generally acknowledged to having superior sound quality. It has the same five full range channels plus the subwoofer channel.

### DTS-ES

DTS ES is a 5.1 channel format based on DTS 5.1. There is an additional center rear channel that is matrix encoded into the rear surround channels for playback.

### DTS-ES 6.1 Discrete

This is a true discrete 6.1 channel sound format. Unlike DTS ES, this format has a true sixth channel mixed into the soundtracks. The DTS 6.1 Discrete mode only operates on sources with DTS 6.1 encoding. A list of available DVD titles with DTS ES and 6.1 Discrete can be found at [www.dtsonline.com](http://www.dtsonline.com)

### DTS Neo:6 Cinema

A movie surround decoding mode designed to provide a movie theater environment soundstage with natural steering to all available surround channels.

### DTS Neo:6 Music

Similar to the Cinema mode but with a tighter surround effect for most musical material.

### DSP Effects Modes

The Maestro M2e has several DSP effects modes to enhance playback of a two channel audio source through the surround speakers. These modes are only available on stereo audio sources.

### Effects Modes

**MUSIC** - Music surround makes full use of the additional speakers in a theater system. This effect uses ambience extraction for the side and rear speakers and offers the most subtle surround processing with no reverberation or reflection sounds.

**PARTY** - The Party mode allows unprocessed stereo signals to be played over all the speakers for background music or maximum sound levels.

**CLUB** - The Club effect generates reflections and short reverberation to the front, side and rear speakers. It simulates a small night club venue.

**CONCERT HALL** - The Concert Hall effect generates the ambient information of a medium sized performance hall. Reflections and medium length reverberation information is sent to all channels.

**SPORTS** - The Sports Stadium effect is ideal for watching live sporting events. The open ambience is actively created around you. The center channel is used for the dialog commentary.

**CHURCH** - The Church effect uses a reverberation algorithm that emphasizes the smooth, rich reverberant sound of a large space. As the name suggests, it works well for simulating the long reverberation of a cathedral or church.

### Modes for Analog Source Material

Two channel analog audio source material does not contain surround encoding information. This means that you will have to manually choose the surround mode that you find sounds best.

#### Two-channel Audio Source Modes

The following surround modes are available with two channel audio sources. These include Stereo Analog, Dolby Digital 2.0 and PCM 2-channel digital sources.

#### Mono

The left and right channels are combined into a single mono mix. This can benefit some older recordings and video tapes.

### Stereo

The Maestro M2e works like a traditional audio preamplifier in this mode. This mode plays back analog audio sources along with 2 channel digital sources such as Dolby Digital 2.0 from some DVD players and PCM digital CDs.

### Dolby Pro Logic II/IIx

This provides better surround channel separation than the original ProLogic format. There are two ProLogic II surround modes: Music and Movie. Use the method that sounds best to you.

### Dolby Pro Logic Emulation

This mode should only be used on ProLogic encoded source materials. ProLogic processing on pure stereo sources can sound muffled and is not recommended.

### Mode Memory

The Maestro M2e automatically remembers the last surround mode used for each source input. Since most digital surround recordings have control information encoded into them; the Maestro M2e will switch to the decoding method requested by the source material.

Some Dolby Digital Surround EX soundtracks are missing the digital flag the enables automatic switching. If you know that a movie you are watching is encoded in Surround EX, you can manually select the THX Surround EX surround mode with the THX button.

A list of available DVD titles encoded with Dolby Digital Surround EX technology can be found at [www.thx.com](http://www.thx.com) or [www.dolby.com](http://www.dolby.com).



## Automation Integration

### Introduction

Part of the joy of a great home theater is that you don't have a tray of remote controls staring at you whenever you want to watch a movie. Hidden away behind the scenes is a workhorse that takes care of the mundane tasks of turning on all the components, lowering the curtains, dimming the lights, popping the corn, etc. This faithful servant can take the form of a simple learning remote control or a system as capable as a whole house automation system with touchscreens. There is a wide variety of theater controllers available.

There are two means of remotely controlling the Maestro M2e: With Infrared (IR) Remote control and with the RS-232 Serial Port. Both of these methods feature a very extensive library of commands. It is really up to the system designers choice of user interface as to which of these methods will be used. It is possible to use both of these in the same installation depending on your needs.

### Infrared Control versus RS-232

Infrared remote control systems are typically less expensive than RS-232 controllers. Their main limitation is that Infrared is strictly line-of-sight. That means that there has to be an unobstructed view between the controller sending the infrared commands and the IR sensor or front panel of the Maestro M2e. When you try to send long groups of commands (macros) such as: Turn on the TV, Turn on the Maestro M2e, Turn on the DVD, Select the DVD Input on the Maestro M2e, Play the DVD; everything can easily get out of sync if you sit down the IR controller or somebody walks in front of you before all the Infrared commands have been sent. Infrared is also typically a one-way communication. There is no way for the IR remote to know if the command was received correctly.

RS-232 Serial control is a hard-wired connection. There is usually a wire connecting the user interface (keypad or touchscreen) to the controller system. Then another wire connecting the controller system to the Maestro M2e. RS-232 is also a two-way communications scheme. This allows

the controller system to send very long, complex strings of commands and get an answer back to know that all those commands were executed properly.

## RS-232 Serial Control

You must set the external RS-232 control system serial port to match the data communication speed and format of the Maestro M2e. If these settings are not correct, the Maestro M2e will not respond to the commands.

Maestro M2e communication parameters:

Baud Rate:	38,400
Start Bit:	1
Data Bits:	8
Stop Bit:	1
Parity:	None
Flow Control:	None

## Cable Wiring

The cable wiring to connect the Maestro M2e to your control system will depend on the RS-232 output connection on the controller. Make certain that you wire the Transmit Data output on the serial controller to the Receive Data on the Maestro M2e and vice versa on the Receive Data line on the controller system. Connect the signal grounds on the control system and the Maestro M2e together. The RS-232 connection on the Maestro M2e is a DB-9 Male wired as follows:

- Pin 2 Receive Data (RXD)
- Pin 3 Transmit Date (TXD)
- Pin 5 Ground

To connect the Maestro M2e to a standard PC serial comm port; wire the cable in a 'null modem' arrangement using the appropriate serial cable.

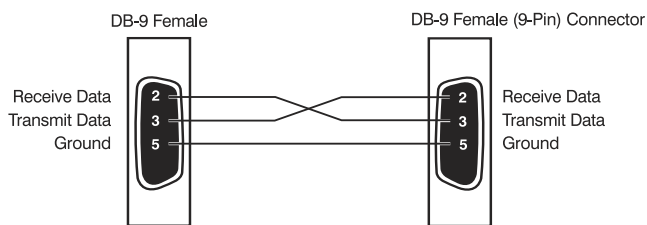

RS-232 Null Modem Arrangement

## Command Structure

The RS-232 serial control protocol structure of the Maestro M2e is a string of ASCII characters with all Commands terminated with an ASCII carriage return (0xd hexadecimal).

## Issuing Commands

Each transmission to the Maestro M2e is seven bytes long and uses the following format:

<STR><CC><P1><P2><ETR>

Parameter	Command	Description
STR	"PC_"	Begins transmission to Maestro M2e
CC	see table page 47	Command code which determines type of function (ie. Power, Volume Control, Zone Selection, etc.)
P1	"1", "2", or "~"	Specifies which Zone or Tuner
P2	"1 - 9"	Represents individual functions based on the above Command Code (ie. On, Off, Mute, Source Selection, Surround Modes)
ETR	Carriage Return	End transmission

Note: ALL commands are entered in Uppercase.

## As an example:

Power up the Maestro M2e: PC\_\*11 <cr>

Mute the audio output on the main zone: PC\_.10 <cr>

### Receiving Commands

Command processing begins when the first semicolon separator line feed terminator is received. When a command is executed properly, the Maestro M2e echoes the command back in the following format:

<STR><RC><AC><Px><ETR>

Parameter	Command	Description
STR	"AV_"	Begins transmission
RC		Reply code
AC	"P" or "R"	Answer Code – "P"(command accepted), "R"(command error)
P1	"1" or "2"	Zone – Determines which zone the command controlled
P2	"1 – 9"	Represents individual functions based on the above Command Code (ie. On, Off, Mute, Source Selection, Surround Modes)
ETR	Carriage Return	End transmission

### As an example:

Confirming Power up of the Maestro M2e: AV\_\*P11 <cr>

Confirming Mute of the audio output on the main zone:

AV\_.P10 <cr>

### Manually Determining RS-232 Codes

When attempting to determine a specific command sequence for the Maestro M2e, it is sometime helpful to connect the Maestro M2e to a terminal emulator program (like Hyperterminal) and utilize the information from the Receiving Command. Physically perform the function on the Maestro M2e (ie. adjust the volume knob, select a source, change a surround effect), your Maestro M2e will transmit a Receiving Command and you can use the command on your screen to determine the specific RS-232 command.

**MAESTRO M2e RS232 COMMAND PROGRAMMING GUIDE**

Function	Selection	ASCII					Hex
		STR	CC	P1	P2	ETR	
Power / Standby On / Off	On	PC_	*	1	1	(0xd)	(0x2a)(0x31)(0x31)
	Off	PC_	*	1	0	(0xd)	(0x2a)(0x31)(0x30)
	Request	PC_	*	1	9	(0xd)	(0x2a)(0x31)(0x39)
Display Brightness	Off	PC_	+	1	0	(0xd)	(0x2b)(0x31)(0x30)
	Dim	PC_	+	1	1	(0xd)	(0x2b)(0x31)(0x31)
	Bright	PC_	+	1	2	(0xd)	(0x2b)(0x31)(0x32)
	Request	PC_	+	1	9	(0xd)	(0x2b)(0x31)(0x39)
Open Menu	Main	PC_	","	1	1	(0xd)	(0x2c)(0x31)(0x31)
	Setup	PC_	","	1	2	(0xd)	(0x2c)(0x31)(0x32)
	Trim	PC_	","	1	3	(0xd)	(0x2c)(0x31)(0x33)
	Sub Trim	PC_	","	1	4	(0xd)	(0x2c)(0x31)(0x34)
	Lip Sync	PC_	","	1	5	(0xd)	(0x2c)(0x31)(0x35)
	Request	PC_	","	1	9	(0xd)	(0x2c)(0x31)(0x39)
Close Menu	Main	PC_	-	1	1	(0xd)	(0x2d)(0x31)(0x31)
	Setup	PC_	-	1	2	(0xd)	(0x2d)(0x31)(0x32)
	Trim	PC_	-	1	3	(0xd)	(0x2d)(0x31)(0x33)
	Any Open Menu	PC_	-	1	4	(0xd)	(0x2d)(0x31)(0x34)
	Request	PC_	-	1	9	(0xd)	(0x2d)(0x31)(0x39)
Mute - Zone 1	Mute	PC_	.	1	0	(0xd)	(0x2e)(0x31)(0x30)
	Un-Mute	PC_	.	1	1	(0xd)	(0x2e)(0x31)(0x31)
	Request	PC_	.	1	9	(0xd)	(0x2e)(0x31)(0x39)
Mute - Zone 2	Mute	PC_	.	2	0	(0xd)	(0x2e)(0x32)(0x30)
	Unmute	PC_	.	2	1	(0xd)	(0x2e)(0x32)(0x31)
	Request	PC_	.	2	9	(0xd)	(0x2e)(0x32)(0x39)
Volume Change - Zone 1	Up	PC_	/	1	1	(0xd)	(0x2f)(0x31)(0x31)
	Down	PC_	/	1	0	(0xd)	(0x2f)(0x31)(0x30)
	Request	PC_	/	1	9	(0xd)	(0x2f)(0x31)(0x39)
Volume Change - Zone 2	Up	PC_	/	2	1	(0xd)	(0x2f)(0x32)(0x31)
	Down	PC_	/	2	0	(0xd)	(0x2f)(0x32)(0x30)
	Request	PC_	/	2	9	(0xd)	(0x2f)(0x32)(0x39)
Source Selection Zone 1	DVD	PC_	1	1	0	(0xd)	(0x31)(0x31)(0x30)
	SAT	PC_	1	1	1	(0xd)	(0x31)(0x31)(0x31)
	AV	PC_	1	1	2	(0xd)	(0x31)(0x31)(0x32)
	AUX	PC_	1	1	3	(0xd)	(0x31)(0x31)(0x33)
	VCR	PC_	1	1	4	(0xd)	(0x31)(0x31)(0x34)
	CD	PC_	1	1	5	(0xd)	(0x31)(0x31)(0x35)
	FM	PC_	1	1	6	(0xd)	(0x31)(0x31)(0x36)
	AM	PC_	1	1	7	(0xd)	(0x31)(0x31)(0x37)
	DVDA	PC_	1	1	8	(0xd)	(0x31)(0x31)(0x38)
	Request	PC_	1	1	9	(0xd)	(0x31)(0x31)(0x39)
Source Selection Zone 2	DVD	PC_	1	2	0	(0xd)	(0x31)(0x32)(0x30)
	SAT	PC_	1	2	1	(0xd)	(0x31)(0x32)(0x31)
	AV	PC_	1	2	2	(0xd)	(0x31)(0x32)(0x32)
	AUX	PC_	1	2	3	(0xd)	(0x31)(0x32)(0x33)
	VCR	PC_	1	2	4	(0xd)	(0x31)(0x32)(0x34)
	CD	PC_	1	2	5	(0xd)	(0x31)(0x32)(0x35)
	FM	PC_	1	2	6	(0xd)	(0x31)(0x32)(0x36)
	AM	PC_	1	2	7	(0xd)	(0x31)(0x32)(0x37)

STR = START TRANSMISSION

CC = COMMAND CODE

AC = ANSWER CODE

"Px = PARAMETER CODE 1st Digit = 1 for Zone 1, 2 for Zone 2, 2nd Digit = Function"

ETR = END OF TRANSMISSION

**AudioControl** *Maestro M2e*™

Phone 425-775-8461 • Fax 425-778-3166

# Automation Integration

Function	Selection	ASCII					Hex
		STR	CC	P1	P2	ETR	
	DVDA	PC_	1	2	8	(0xd)	(0x31)(0x32)(0x38)
	Request	PC_	1	1	9	(0xd)	(0x31)(0x32)(0x39)
Direct Mode	Off	PC_	3	1	0	(0xd)	(0x33)(0x31)(0x30)
	On	PC_	3	1	1	(0xd)	(0x33)(0x31)(0x31)
	Request	PC_	3	1	9	(0xd)	(0x33)(0x31)(0x39)
Decode Mode 2 Channel	Mono	PC_	4	1	.	(0xd)	(0x34)(0x31)(0x2e)
	Stereo	PC_	4	1	/	(0xd)	(0x34)(0x31)(0x2f)
	ProLogicII Movie	PC_	4	1	0	(0xd)	(0x34)(0x31)(0x30)
	ProLogicII Music	PC_	4	1	1	(0xd)	(0x34)(0x31)(0x31)
	ProLogicIIx Movie	PC_	4	1	3	(0xd)	(0x34)(0x31)(0x33)
	ProLogicIIx Music	PC_	4	1	4	(0xd)	(0x34)(0x31)(0x34)
	Dolby Pro Emul	PC_	4	1	6	(0xd)	(0x34)(0x31)(0x36)
	NEO: 6 Cinema	PC_	4	1	7	(0xd)	(0x34)(0x31)(0x37)
	NEO: 6 Music	PC_	4	1	8	(0xd)	(0x34)(0x31)(0x38)
	Request	PC_	4	1	9	(0xd)	(0x34)(0x31)(0x39)
	Decode Mode Multi-CH	Mono Down Mix	PC_	5	1	.	(0xd)
Stereo Down Mix		PC_	5	1	/	(0xd)	(0x35)(0x31)(0x2f)
Multichannel Mode		PC_	5	1	0	(0xd)	(0x35)(0x31)(0x30)
Dolby EX Mode		PC_	5	1	1	(0xd)	(0x35)(0x31)(0x31)
Pro Logic IIx Movie		PC_	5	1	2	(0xd)	(0x35)(0x31)(0x32)
Pro Logic IIx Music		PC_	5	1	3	(0xd)	(0x35)(0x31)(0x33)
Request		PC_	5	1	9	(0xd)	(0x35)(0x31)(0x39)
Effect		Off	PC_	6	1	0	(0xd)
	Music	PC_	6	1	1	(0xd)	(0x36)(0x31)(0x31)
	Party	PC_	6	1	2	(0xd)	(0x36)(0x31)(0x32)
	Club	PC_	6	1	3	(0xd)	(0x36)(0x31)(0x33)
	Hall	PC_	6	1	4	(0xd)	(0x36)(0x31)(0x34)
	Sports	PC_	6	1	5	(0xd)	(0x36)(0x31)(0x35)
	Church	PC_	6	1	6	(0xd)	(0x36)(0x31)(0x36)
	Request	PC_	6	1	9	(0xd)	(0x36)(0x31)(0x39)
Analog / Digital	Analog	PC_	7	1	0	(0xd)	(0x37)(0x31)(0x30)
	Digital	PC_	7	1	1	(0xd)	(0x37)(0x31)(0x31)
	Request	PC_	7	1	9	(0xd)	(0x37)(0x31)(0x39)
Navigation	Cursor Up	PC_	8	1	:	(0xd)	(0x38)(0x0x31)(0x3a)
	Cursor Down	PC_	8	1	:	(0xd)	(0x38)(0x0x31)(0x3b)
	Cursor Left	PC_	8	1	<	(0xd)	(0x38)(0x0x31)(0x3c)
	OK	PC_	8	1	=	(0xd)	(0x38)(0x0x31)(0x3d)
	Cursor Right	PC_	8	1	>	(0xd)	(0x38)(0x0x31)(0x3e)
Tuner	Tune Down	PC_	@	~	0	(0xd)	(0x40)(0x7e)(0x30)
	Tune Up	PC_	@	~	1	(0xd)	(0x40)(0x7e)(0x31)
	Request	PC_	@	~	9	(0xd)	(0x40)(0x7e)(0x39)
RDS / SYSTEM	Station Frequency	PC_	A	~	0	(0xd)	(0x41)(0x7e)(0x30)
	Station Name	PC_	A	~	1	(0xd)	(0x41)(0x7e)(0x31)
	Station Text	PC_	A	~	2	(0xd)	(0x41)(0x7e)(0x32)
	Request	PC_	A	~	9	(0xd)	(0x41)(0x7e)(0x39)

STR = START TRANSMISSION "PC\_"

CC = COMMAND CODE

P1 = ZONE OR TUNER

P2 = FUNCTION

ETR = END OF TRANSMISSION (CARRIAGE RETURN)

**COMMAND SPECIFICATIONS TABLES**  
**Maestro M2e RS232 RESPONSE PROGRAMMING GUIDE**

Function	Selection	ASCII					Hex
		STR	CC	AC	Px	ETR	
Power / Standby On / Off	On	AV_	*	P	11	(0xd)	(0x2a)(0x31)(0x31)
	Standby	AV_	*	P	10	(0xd)	(0x2a)(0x31)(0x30)
Display Brightness	Off	AV_	+	P	10	(0xd)	(0x2b)(0x31)(0x30)
	Dim	AV_	+	P	11	(0xd)	(0x2b)(0x31)(0x31)
	Bright	AV_	+	P	12	(0xd)	(0x2b)(0x31)(0x32)
Menu Open	Main	AV_	","	P	11	(0xd)	(0x2c)(0x31)(0x31)
	Setup	AV_	","	P	12	(0xd)	(0x2c)(0x31)(0x32)
	Trim	AV_	","	P	13	(0xd)	(0x2c)(0x31)(0x33)
	Sub Trim	AV_	","	P	14	(0xd)	(0x2c)(0x31)(0x34)
	Lip Sync	AV_	","	P	15	(0xd)	(0x2c)(0x31)(0x35)
Menu Closed	Main	AV_	-	P	11	(0xd)	(0x2d)(0x31)(0x31)
	Setup	AV_	-	P	12	(0xd)	(0x2d)(0x31)(0x32)
	Trim	AV_	-	P	13	(0xd)	(0x2d)(0x31)(0x33)
	Any Open Menu	AV_	-	P	14	(0xd)	(0x2d)(0x31)(0x34)
Mute - Zone 1	Mute	AV_	.	P	10	(0xd)	(0x2e)(0x31)(0x30)
	Un-Mute	AV_	.	P	11	(0xd)	(0x2e)(0x31)(0x31)
Mute - Zone 2	Mute	AV_	.	P	20	(0xd)	(0x2e)(0x32)(0x30)
	Unmute	AV_	.	P	21	(0xd)	(0x2e)(0x32)(0x31)
Volume Change - Zone 1	Up	AV_	/	P	11	(0xd)	(0x2f)(0x31)(0x31)
	Down	AV_	/	P	10	(0xd)	(0x2f)(0x31)(0x30)
Volume Change - Zone 2	Up	AV_	/	P	21	(0xd)	(0x2f)(0x32)(0x31)
	Down	AV_	/	P	20	(0xd)	(0x2f)(0x32)(0x30)
Selected Source Zone 1	DVD	AV_	1	P	10	(0xd)	(0x31)(0x31)(0x30)
	SAT	AV_	1	P	11	(0xd)	(0x31)(0x31)(0x31)
	AV	AV_	1	P	12	(0xd)	(0x31)(0x31)(0x32)
	AUX	AV_	1	P	13	(0xd)	(0x31)(0x31)(0x33)
	VCR	AV_	1	P	14	(0xd)	(0x31)(0x31)(0x34)
	CD	AV_	1	P	15	(0xd)	(0x31)(0x31)(0x35)
	FM	AV_	1	P	16	(0xd)	(0x31)(0x31)(0x36)
	AM	AV_	1	P	17	(0xd)	(0x31)(0x31)(0x37)
Selected Source Zone 2	DVDA	AV_	1	P	18	(0xd)	(0x31)(0x31)(0x38)
	DVD	AV_	1	P	20	(0xd)	(0x31)(0x32)(0x30)
	SAT	AV_	1	P	21	(0xd)	(0x31)(0x32)(0x31)
	AV	AV_	1	P	22	(0xd)	(0x31)(0x32)(0x32)
	AUX	AV_	1	P	23	(0xd)	(0x31)(0x32)(0x33)
	VCR	AV_	1	P	24	(0xd)	(0x31)(0x32)(0x34)
	CD	AV_	1	P	25	(0xd)	(0x31)(0x32)(0x35)
	FM	AV_	1	P	26	(0xd)	(0x31)(0x32)(0x36)
Direct Mode	Off	AV_	3	P	10	(0xd)	(0x33)(0x31)(0x30)
	On	AV_	3	P	11	(0xd)	(0x33)(0x31)(0x31)
Decode Mode	Mono	AV_	1	P	.	(0xd)	(0x34)(0x31)(0x2e)
	Stereo	AV_	4	P	/	(0xd)	(0x34)(0x31)(0x2f)
	ProLogicII Movie	AV_	4	P	10	(0xd)	(0x34)(0x31)(0x30)
	ProLogicII Music	AV_	4	P	11	(0xd)	(0x34)(0x31)(0x31)
	ProLogicIIx Movie	AV_	4	P	13	(0xd)	(0x34)(0x31)(0x33)

# Automation Integration

Function	Selection	ASCII					Hex
		STR	CC	AC	Px	ETR	
ProLogicIIx Music	AV_	4	P	14	(0xd)	(0x34)(0x31)(0x34)	
	Dolby Pro Emul	AV_	4	P	16	(0xd) (0x34)(0x31)(0x36)	
	NEO: 6 Cinema	AV_	4	P	17	(0xd) (0x34)(0x31)(0x37)	
	NEO: 6 Music	AV_	4	P	18	(0xd) (0x34)(0x31)(0x38)	
Effect	Off	AV_	6	P	10	(0xd) (0x36)(0x31)(0x30)	
	Music	AV_	6	P	11	(0xd) (0x36)(0x31)(0x31)	
	Party	AV_	6	P	12	(0xd) (0x36)(0x31)(0x32)	
	Club	AV_	6	P	13	(0xd) (0x36)(0x31)(0x33)	
	Hall	AV_	6	P	14	(0xd) (0x36)(0x31)(0x34)	
	Sports	AV_	6	P	15	(0xd) (0x36)(0x31)(0x35)	
	Church	AV_	6	P	16	(0xd) (0x36)(0x31)(0x36)	
	Analog / Digital	Analog	AV_	7	P	10	(0xd) (0x37)(0x31)(0x30)
	Digital	AV_	7	P	11	(0xd) (0x37)(0x31)(0x31)	
Navigation	Cursor Up	AV_	8	P	1:	(0xd) (0x38)(0x0x31)(0x3a)	
	Cursor Down	AV_	8	P	1:	(0xd) (0x38)(0x0x31)(0x3b)	
	Cursor Left	AV_	8	P	1<	(0xd) (0x38)(0x0x31)(0x3c)	
	OK	AV_	8	P	1=	(0xd) (0x38)(0x0x31)(0x3d)	
	Cursor Right	AV_	8	P	1>	(0xd) (0x38)(0x0x31)(0x3e)	
Tuner	Tune Down	AV_	@	P	~0	(0xd) (0x40)(0x7e)(0x30)	
	Tune Up	AV_	@	P	~1	(0xd) (0x40)(0x7e)(0x31)	
RDS / SYSTEM	Station Frequency	AV_	A	P	~0	(0xd) (0x41)(0x7e)(0x30)	
	Station Name	AV_	A	P	~1	(0xd) (0x41)(0x7e)(0x31)	
	Station Text	AV_	A	P	~2	(0xd) (0x41)(0x7e)(0x32)	

STR = START TRANSMISSION

CC = COMMAND CODE

AC = ANSWER CODE

"Px = PARAMETER CODE 1st Digit = 1 for Zone 1, 2 for Zone 2, 2nd Digit = Function"

ETR = END OF TRANSMISSION



## Table of IR Remote Control Commands

The Maestro M2e uses standard RC-5 encoding for the infrared (IR) remote control. Here is a table of the commands available including all discrete function commands. There is a full copy of these IR commands in Pronto CCF format included on the AudioControl Home Theater System Support CD included with the Maestro M2e.

Depending if these IR commands are received through the Front Panel receiver of the Maestro M2e or the Zone 2 IR input, they will control Zone 1 or Zone 2.

Command	Code	Command	Code
Standby	16-124	Dolby PL2 Music	16-109
Power On	16-123	Dolby ProLogic	16-110
Power Toggle	16-12	DTS NEO 6 Cinema	16-111
Display	16-59	DTS NEO 6 Music	16-112
Menu	16-82	THX Off	16-113
Info	16-55	THX Cinema	16-114
Mute	16-119	THX Ultra2 Cinema	16-115
Unmute	16-120	THX Music	16-116
Mute Toggle	16-13	THX Surround EX	16-117
Volume Up	16-16	Effect: Off	16-63
Volume Down	16-17	Effect: Music	16-64
SAT Input	16-0	Effect: Party	16-65
AV Input	16-2	Effect: Club	16-66
Tuner Input	16-3	Effect: Hall	16-67
DVD Input	16-4	Effect: Sport	16-68
Tape Input	16-5	Effect: Church	16-69
VCR Input	16-6	Preset 1	16-72
CD Input	16-7	Preset 2	16-73
AUX Input	16-8	Preset 3	16-74
Multi-Chan Input	16-9	Preset 4	16-75
Direct On	16-78	Preset 5	16-76
Direct Off	16-79	Arrow Up	16-85
Direct Toggle	16-10	Arrow Down	16-86
Modes Toggle	16-28	Arrow Left	16-81
THX Modes	16-32	Arrow Right	16-80
Effects Toggle	16-70	Select	16-87
Mono Mode	16-106	Trim Menu	16-37
Stereo Mode	16-107	Sub Trim	16-51
Dolby PL2 Movie	16-108	Lip Sync	16-50



## Troubleshooting Common Problems

### General

There are no lights on the Maestro M2e

- ✓ Pressing any Source selection or the Standby button on the front panel should wake the Maestro M2e.
- ✓ Verify that the power cord is plugged into a live AC outlet.
- ✓ Verify that the rear panel Power switch on the Maestro M2e is pressed in (On).

The main front panel display is blank

- ✓ Press the Display button. This button controls the display brightness and also allows you to turn the display off entirely.

The main zone changes while selecting sources from Zone 2

- ✓ Change the Zone 1 Control option in the Zone 2 Configuration Menu to Off.

### Video

No video/picture

- ✓ Verify your video display or projector is turned on and set to the correct input for the Maestro M2e. Press the Menu button on the Maestro M2e and look for the Main Menu to show on the video display.
- ✓ Verify the correct input on the video display is selected for the output of the source (i.e. Component Video if the output of the DVD player is Component).
- ✓ Verify the Video Input assignment configurations. Make certain that the correct video input is assigned to the source you are playing.

No Video on Zone 2

- ✓ Verify the composite video input from source is connected.

There is no On-Screen Display (OSD)

- ✓ Verify the OSD is turned on in the Maestro M2e configuration settings.
- ✓ Verify that the correct input is selected on the video display or projector.

The OSD is pink/red

- ✓ Verify that the HQ Video Mode is set to Component in the Maestro M2e configuration settings. If this is set to RGB, the on-screen display will be pink or red.

No On-Screen Display overlaid on video

- ✓ The Maestro M2e cannot overlay the OSD onto video signals that have a higher than normal scan rate such as Progressive or HDTV. The Maestro M2e automatically switches to Full Screen mode with black background when receiving these video signals.

No Video On Active Balanced Outputs

- ✓ Confirm that the RJ-45 connectors on the CAT-5 cable are terminated properly. Using a cable tester is recommended.
- ✓ Confirm that you have selected the component output as it parallels to the Active Balanced Output.

### Audio

The audio doesn't match the video

- ✓ The Video and Audio input can be selected independently in the Main Menu. Verify they are set the same.
- ✓ Verify the correct Video Input and Digital Audio input assignments are configured for the Source input button.

The sound is poor or distorted

- ✓ Verify the speaker settings configuration matches your speakers. If a speaker is set to Large and it cannot reproduce full range bass, you will hear distortion.
- ✓ If the trouble is only on some channels: Verify the audio RCA cables to the power amplifiers are working and seated properly.
- ✓ If the trouble is in all channels: Verify the Input Trim setting in the Advanced Configurations is not set too low.

### Cannot select Dolby Digital or DTS decoding mode

- ✓ The Maestro M2e can only decode formats encoded onto the source. Normally these are marked on the packaging or liner notes of the material.
- ✓ Verify that the correct format is selected in the Start menu of the DVD.
- ✓ Verify that the digital input from the source is properly connected to the Maestro M2e.
- ✓ Verify that the digital output of the source is enabled. Some DVD players have a setup menu that can only be accessed if there is no disk in the player.

### Hum on analog inputs

- ✓ Verify that all the two channel analog audio cables are connected properly.
- ✓ If the hum only occurs on one source, try a different set of connecting cables.
- ✓ If the hum occurs on a source with an external connection such as an antenna or cable TV, try disconnecting that input. If the hum disappears, put a ground isolator on that connection.
- ✓ Try switching the ground lift switch on the back panel of the Maestro M2e.

### No Zone 2 audio when playing a DTS encoded video

- ✓ Most DVD players cannot output a stereo analog version of the soundtrack while playing a DTS encoded disk. If you want to watch the movie in the second zone, select the Dolby Digital soundtrack on the disk.

### Unable to adjust the Bass and Treble controls

- ✓ The Bass and Treble tone controls are defeated.

### No Digital Audio On Active Balanced Outputs

- ✓ Confirm that the "Remote Power/Digital Audio" button on the back panel is in the "Out" position.
- ✓ If you are using a BVR-25, active balanced receiver, make sure that the rear jumpers on the BVR-25 are in the "A/V position".



## Appendix A

### Using the Maestro M2e with the Diva Room Correction Processor

While the Maestro M2e is a very powerful surround processor, some things are best left to a specialist. The Diva 24 bit digital room correction processor is the part of the AudioControl Perfection Home Theater System product line up designed to take the theaters sound quality up to the next level. The Diva includes Graphic and Parametric Equalization, Digital Delays with 0.01 mS resolution, Crossover filtering, and Compressor/Limiter Dynamics control for 8 channels of audio. It also includes 20 user-configured preset memories and a powerful automation integration protocol to make this part of any dream system.

The Diva is simple to connect into the Maestro M2e home theater system. The analog inputs and outputs enable the Diva to connect between the preamplifier outputs of the Maestro M2e and the inputs of your power amplifiers (preferably the Pantages and Avalon).

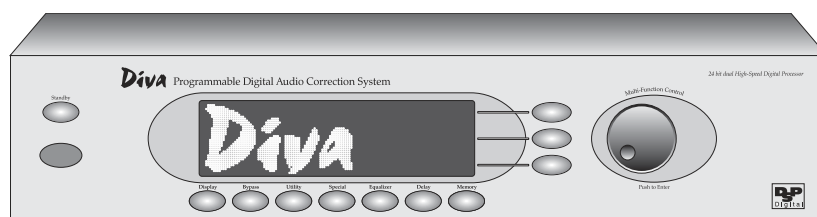

For adjusting the Diva, we highly recommend using the AudioControl Industrial IasysHT theater analyzer with the HT-100 switcher. The IasysHT enables extremely precise one-twelfth audio analysis for treating room acoustic mode problems. The IasysHT is also very capable with speaker delay measurements. It will measure delay timings down to 1/8" to ensure the best sound imaging that you have ever heard from a home theater.

## Appendix B - Factory Theater Calibration Service

An integral part of the AudioControl Perfection Home Theater system is the acoustical calibration of the system. Especially in systems where the power of the Diva room correction processor is used. To help with this task, AudioControl offers a Factory Theater Calibration Service. A factory-trained technician using the AudioControl Industrial IasysHT theater analyzer and other tools of the trade, will come to your theater and ensure that you are getting the best sound possible from your system.

For more information about this service, contact your AudioControl sales representative or dealer.





### Appendix C – Using The Active Balanced Outputs On Your Maestro M2e

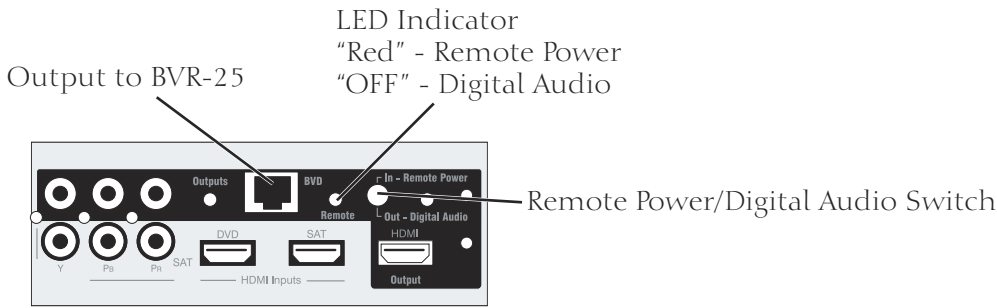
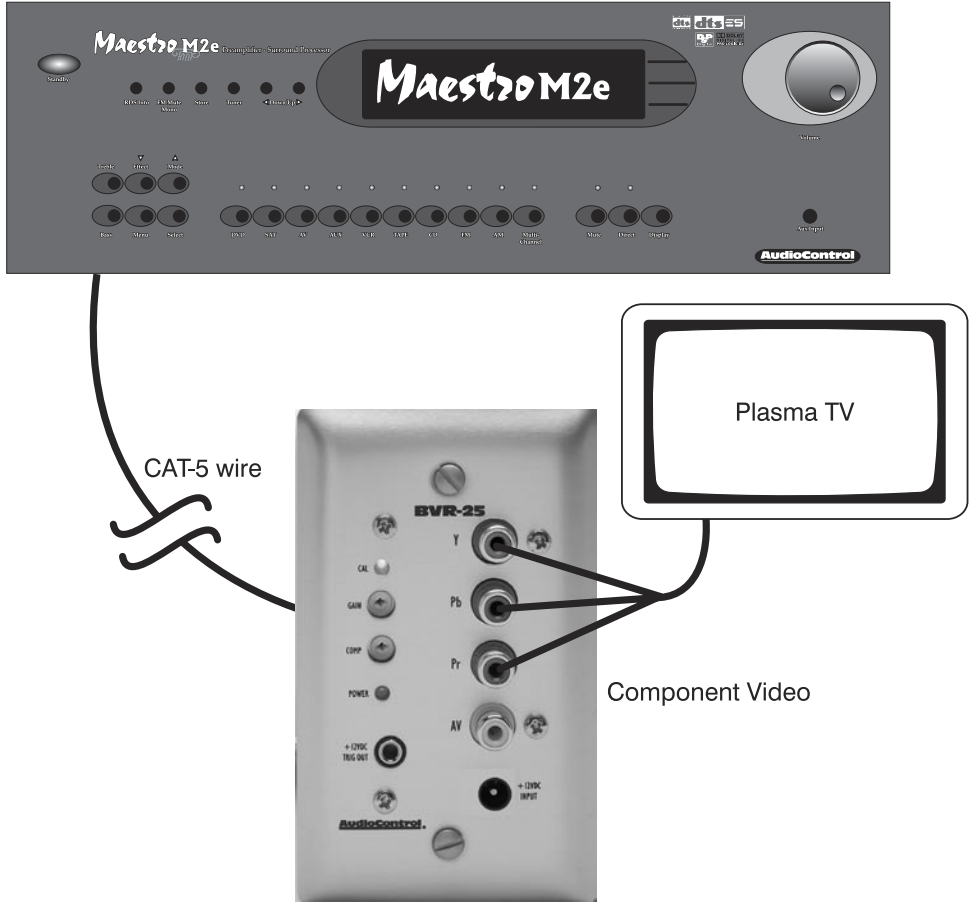

Active Balanced Outputs on Maestro M2e

## Warranty

*and now a word from the legal department...*

People are scared of warranties. Lots of fine print. Months of waiting around. Well, fear no more. This warranty is designed to make you rave about us to your friends. It's a warranty that looks out for you and helps you resist the temptation to have your friend, who's "good with electronics", try to repair your AudioControl product. So go ahead, read this warranty, then take a few days to enjoy your new Maestro M2e home theater system before sending in the warranty card and comments.

"Conditional" doesn't mean anything ominous. The Federal Trade Commission tells all manufacturers to use the term to indicate that certain conditions have to be met before they'll honor the warranty. If you meet all of these conditions, we will warrant all materials and workmanship on the Maestro M2e for five (5) years from the date you bought it, and we will fix or replace it, at our option, during that time.

Here are the conditional conditions:

1. You have to fill out the warranty card and send it to us within 15 days after purchasing the Maestro M2e.
2. You must keep your sales receipt for proof of purchase showing when and from whom the unit was bought. We're not the only ones who require this, so it's a good habit to get into with any major purchase.
3. The Maestro M2e must have originally been purchased from an authorized AudioControl dealer. You do not have to be the original owner, but you do need a copy of the original sales receipt or invoice.
4. You cannot let anybody who isn't: (A) the AudioControl factory; (B) somebody authorized in writing by AudioControl to service the Maestro M2e. If anyone other than (A) or (B) messes with the Maestro M2e, that voids your warranty.

**Maestro M2e™ AudioControl®**

Phone 425-775-8461 • Fax 425-778-3166

5. The warranty is also void if the serial number is altered or removed, or if the Maestro M2e has been used improperly. Now that sounds like a big loophole, but here is all we mean by it:

Unwarranted abuse is: (A) physical damage (don't use the Maestro M2e to level your projection TV); (B) improper connections (120 volts into the RCA jacks can fry the poor thing); (C) sadistic things. This is the best product we know how to build, but if you strap it to the front bumper of your Range Rover, something will break.

Assuming you conform to 1 through 5 (and it really isn't all that hard to do) we get the option of fixing your original unit or replacing it with a new one.

#### Legalese Section

This is the only warranty given by AudioControl. This warranty gives you specific legal rights that vary from state to state. Promises of how well the Maestro M2e will perform are not implied by this warranty. Other than what we have covered in this warranty, we have no obligation, express or implied. Also, we will not be obligated for direct or indirect consequential damage to your system caused by hooking up or operating the AudioControl Maestro M2e.

Failure to send in a properly completed warranty card negates any service claims.

---

## What to do if you need service

Normally service will be handled by your AudioControl system professional who installed the system. If you're the take charge kind of person who wants to do this yourself, contact AudioControl, either by phone 425/775-8461 or email at [service@audiocontrol.com](mailto:service@audiocontrol.com). We'll verify if there is anything wrong that you can fix yourself, or arrange to have it sent back to our factory for repair. Please include the following items with the returning unit:

1. A copy of your proof of purchase (that sales receipt we've been harping about). No originals please. We cannot guarantee returning them to you.
2. A brief explanation of the trouble you are having with the Maestro M2e.
3. A return street address. (No PO Boxes, please)
4. A daytime phone number in case our technician has a question about the problem you are having.

You're responsible for the freight charges to us, but we'll pay the return freight back. We match whatever shipping method you send it to us, so if you return the unit overnight freight, we send it back overnight. We recommend UPS for any shipments.

**Specifications**

**Maestro M2e Theater Surround Processor Specifications**

**Audio**

S/N Ratio (unwtd 20Hz/20kHz) – analog . . . . . >100dB  
S/N Ratio (unwtd 20Hz/20kHz) – digital . . . . . >100dB  
THD - Analog Inputs. . . . . 0.003%  
THD - Digital Inputs (24 bit) . . . . . 0.003%

**Video**

Composite & S-Video Bandwidth . . . . . >12 MHz  
Component Video Bandwidth . . . . . 150 MHz  
HDMI Bandwidth . . . . .

**Digital**

Coaxial Inputs/Outputs (level / impedance) 3/1 @ 0.5V / 75 ohms  
Sampling frequencies . . 44.1 kHz, 48kHz, and 96kHz (stereo only)  
S/PDIF Optical Inputs/Outputs . . . . . 3/1

**Inputs**

Analog Audio Inputs . . . . . 7 Stereo Pairs  
Multi-channel Analog Audio Input . . . . . 1 (8 channels)  
Digital Audio Inputs . . . . . 3 Coax, 3 Optical  
Video Inputs . . . . 5 Composite, 5 S-Video, 3 Component, 2 HDMI

**Outputs**

Main Audio Output . . . . . 8 channels  
Second Zone Audio Output . . . . . 1 Stereo Pair  
Digital Audio Output . . . . . 1 Coax, 1 Optical  
Main Video Outputs. . . . . 1 Composite, 1 Active Balanced,  
1 S-Video, 1 Component, 1 HDMI  
Second Zone Video Output . . . . . 1 Composite

**Control Audio**

12 Volt Trigger Output . . . . . 1 Main, 1 Video  
RS-232 Serial Control . . . . . 1 - DB-9  
IR Receiver Input - Main . . . . . 1 - 3.5 mm Minijack  
IR Receiver Input - Zone 2 . . . . . 1 - 3.5 mm Minijack  
IR Emitter Output . . . . . 1 - 3.5 mm Minijack

**General**

Power Consumption . . . . . 35 Watts  
Dimensions . . . . . 17"W x 15.5"D x 5.25"H  
Weight . . . . . 30 lbs

# **AudioControl®**

*For Those Who Consider Perfection Possible®*  
22410 70th Avenue West  
Mountlake Terrace, WA 98043 USA  
425-775-8461 • Fax 425-778-3166  
[www.AudioControl.com](http://www.AudioControl.com)

P/N 913-090-0